

Liebert® GXT4™ UPS 230V 700VA-3000VA
User Manual



TABLE OF CONTENTS

IMPORTANT SAFETY PRECAUTIONS	1
GLOSSARY OF SYMBOLS	3
1.0 PRODUCT DESCRIPTION	4
1.1 Features	4
1.2 Available Models	4
1.3 Appearance and Components	5
1.3.1 Appearance	5
1.3.2 Rear Panel Features	5
1.4 Major Components	7
1.5 Operating Mode	8
1.5.1 Mains Mode	8
1.5.2 Manual Bypass Mode	8
1.5.3 Battery Mode	9
1.5.4 Battery Recharge Mode	9
1.5.5 Frequency Converter Mode	9
1.5.6 Active ECO Mode	9
2.0 INSTALLATION	10
2.1 Unpacking and Inspection	10
2.2 What's Included	10
2.3 Preparation for Installation	10
2.3.1 Installation Environment	10
2.4 Mechanical Installation	11
2.4.1 Tower Installation	11
2.4.2 Rack Installation	12
2.5 Cable Connection	12
2.5.1 Connecting to AC Mains and Loads	12
2.5.2 Connecting Battery Cables	14
2.6 Connecting Communication Cables	14
2.6.1 Connecting USB Communication Cables	14
2.6.2 Installing the Optional Liebert IntelliSlot® Card and Communication Cables	14
3.0 OPERATION AND DISPLAY PANEL	15
3.1 LED Indicators	15
3.2 Control Buttons	16
3.3 LCD	16
3.4 Menu Structure	17
3.4.1 Startup Screen	18
3.4.2 Default Screen	19
3.4.3 Main Menu Screen	19
3.4.4 Prompt List	29
3.4.5 Warning List	29
3.4.6 Fault List	30
4.0 OPERATION	31

4.1	Startup Checklist for the Liebert GXT4	31
4.2	Starting the UPS	31
4.3	Manual Battery Test	31
4.4	Manual Bypass	31
4.5	Shut Down the Liebert GXT4	32
4.6	Disconnecting Input Power from the Liebert GXT4	32
5.0	COMMUNICATION	33
5.1	Liebert IntelliSlot Communication Cards	33
5.1.1	Liebert MultiLink	33
5.2	USB Port Communication	34
5.2.1	Configuration Program	34
5.3	RS-232 Port	34
5.4	Terminal Block Communication	35
5.4.1	Any Mode Shutdown	35
5.4.2	Battery Mode Shutdown	36
5.4.3	On Battery	36
5.4.4	Low Battery	36
6.0	MAINTENANCE	37
6.1	Replacing the Internal Battery Pack	37
6.1.1	Battery Replacement Procedures	38
6.2	Battery Charging	39
6.3	Precautions	39
6.4	Checking UPS Status	39
7.0	TROUBLESHOOTING	40
7.1	UPS Symptoms	40
7.1.1	Indicator and LCD	40
7.1.2	Audible Alarm	41
7.2	Troubleshooting	41
8.0	BATTERY CABINET	42
9.0	SPECIFICATIONS	43
9.1	Product Warranty Registration	48
9.2	Technical Support	48

FIGURES

Figure 1	Liebert GXT4-700RT230 - GXT4-3000RT230 UPS	5
Figure 2	Rear components, Liebert GXT4 230V 700VA and 1000VA models	5
Figure 3	Rear components, Liebert GXT4 230V 1500VA models	6
Figure 4	Rear components, Liebert GXT4 230V 2000VA models	6
Figure 5	Rear components, Liebert GXT4 230V 3000VA models	6
Figure 6	Operating principle diagram	7
Figure 7	Support bases	11
Figure 8	Remove the front plastic bezel cover	11
Figure 9	Tower installation	12
Figure 10	Cable strain relief	13
Figure 11	Battery cable attachment	14
Figure 12	Operation and display panel	15
Figure 13	Menu structure	17
Figure 14	Startup screen	18
Figure 15	Startup screens	18
Figure 16	Starting and Start Successful screens	18
Figure 17	Default screen	19
Figure 18	Main Menu screen	19
Figure 19	Status screens	20
Figure 20	CONFIGURATION screen	20
Figure 21	UPS screens	21
Figure 22	Battery screen	21
Figure 23	ECO Mode screen	22
Figure 24	Outlet1 screen	22
Figure 25	Outlet Control screen	23
Figure 26	Outlet Setting screen	23
Figure 27	Outlet2 setting screen	24
Figure 28	LCD screen	24
Figure 29	Language screen	24
Figure 30	Color screen	25
Figure 31	Factory Default screen	25
Figure 32	Control screen	25
Figure 33	Turn UPS On or Off screen	26
Figure 34	Alarm Control screen	26
Figure 35	Batt Test screen	26
Figure 36	Log screens	27
Figure 37	Clear Log screen	27
Figure 38	About screen	27
Figure 39	Network screens	28
Figure 40	Terminal Block Communication pin layout	35
Figure 41	Removing the front plastic bezel cover and battery door	38
Figure 42	Disconnecting the battery plug and battery connector (front view)	38
Figure 43	Pulling out the battery	38
Figure 44	Battery cabinet	42

TABLES

Table 1	UPS models, power ratings	4
Table 2	Input circuit breaker specifications	12
Table 3	Type of cord	13
Table 4	Ratings of cord	13
Table 5	LED indicators	15
Table 6	Control buttons	16
Table 7	Prompts and meanings	29
Table 8	Warning list	29
Table 9	Fault list	30
Table 10	Output voltage option, all models	34
Table 11	Replacement battery pack model numbers	37
Table 12	Description of the displayed fault	40
Table 13	Audible alarm description	41
Table 14	Troubleshooting table	41
Table 15	Specifications of GXT4-700RT230/230E and GXT4-1000RT230/230E UPS	43
Table 16	Specifications of the Liebert GXT4-1500RT230/230E, GXT4-2000RT230/230E and GXT-3000RT230/230E	44
Table 17	Operating temperature parameters	45
Table 18	Battery cabinet specifications	45
Table 19	Battery run times	46

IMPORTANT SAFETY PRECAUTIONS



WARNING

Risk of electric shock. Can cause equipment damage, injury or death.

Observe all cautions and warnings in this manual. Failure to do so may result in serious injury or death.

Refer all UPS and battery service to properly trained and qualified service personnel. Do not attempt to service this product yourself.

Opening or removing the cover may expose you to lethal voltages within this unit even when it is apparently not operating and the input wiring is disconnected from the electrical source.

Never work alone.

SAVE THESE INSTRUCTIONS

This manual contains important safety instructions that must be followed during the installation and maintenance of the UPS and batteries. Read this manual thoroughly before attempting to install or operate this UPS.

UPS Safety Notes

The UPS contains no user-serviceable parts except the internal battery pack. Do not remove the cover. Removing the cover may result in electric shock and will invalidate any implied warranty.

The UPS has an internal battery, so the output receptacles of the UPS may carry live voltage even if the UPS is not connected to mains input power.

Before moving or rewiring the UPS, disconnect mains input power and the battery and make sure that the UPS is completely shut down. Otherwise, the output terminal may carry live voltage, presenting an electric shock hazard.

To ensure human safety and normal UPS operation, the UPS must be properly grounded before use.

When the UPS is connected to an IT power distribution system, the short-circuit protection device must be installed on the neutral line.

Install and use the UPS in the following environments:

- Temperature: 0°C to 40°C (32 - 104°F); relative humidity: 0% to 95%, non-condensing)
- Out of direct sunlight
- Away from heat source
- Stable surface, not subject to vibrations or shocks
- Away from dust and other particulates
- Away from corrosive substances, salts and flammable gases

Keep the air inlet and outlet of the UPS unobstructed. Poor ventilation will increase the UPS internal temperature and can shorten the life of the UPS and its batteries.

Keep liquid and other foreign objects away from the UPS.

This UPS is not intended for use with life support and other designated critical devices. Maximum load must not exceed that shown on the UPS rating label. This UPS is designed for data processing equipment. If uncertain, consult your local dealer or Emerson Network Power® representative.

Battery Safety



WARNING

Risk of electric shock and explosion. Can cause equipment damage, injury and death.

Do not dispose of the battery in a fire. The battery may explode.

Do not open or damage the battery. Released electrolyte is toxic and is harmful to skin and eyes. If electrolyte comes into contact with the skin, wash the affected area immediately with plenty of clean water and get medical attention.



WARNING

Risk of electric shock. Can cause equipment damage, injury and death.

A battery can present a risk of electrical shock and high short-circuit current. The following precautions should be observed when working on batteries:

- Remove watches, rings and other metal objects.
- Use tools with insulated handles.
- Wear rubber gloves and boots.
- Do not lay tools or metal parts on top of batteries.
- Disconnect charging source prior to connecting or disconnecting battery terminals.
- Determine if the battery is inadvertently grounded. If it is inadvertently grounded, remove the source of the ground. Contact with any part of a grounded battery can result in electrical shock. The likelihood of such shock will be reduced if grounds are removed during installation and maintenance (applicable to a UPS and a remote battery supply not having a grounded supply circuit).

ELECTROMAGNETIC COMPATIBILITY—The Liebert GXT4 series complies with the limits for a Class A digital device. Operating this device in a residential area is likely to cause harmful interference that users must correct at their own expense.

The Liebert GXT4 series complies with the requirements of EMC Directive 2004/108/EC and the published technical standards. Continued compliance requires installation in accordance with these instructions and use of accessories approved by Emerson®.

Information for the Protection of the Environment

UPS SERVICING—This UPS makes use of components dangerous for the environment (electronic cards, electronic components). The components removed must be taken to specialized collection and disposal centers.

NOTICE TO EUROPEAN UNION CUSTOMERS: DISPOSAL OF OLD APPLIANCES—This product has been supplied from an environmentally aware manufacturer that complies with the Waste Electrical and Electronic Equipment (WEEE) Directive 2002/96/CE.







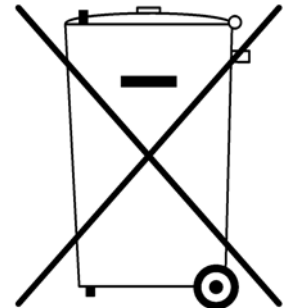

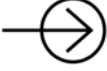

The “crossed-out wheelie bin” symbol at right is placed on this product to encourage you to recycle wherever possible. Please be environmentally responsible and recycle this product through your recycling facility at its end of life. Do not dispose of this product as unsorted municipal waste. Follow local municipal waste ordinances for proper disposal provisions to reduce the environmental impact of waste electrical and electronic equipment (WEEE).

For information regarding the scrapping of this equipment, please browse <http://www.eu.emersonnetworkpower.com> (“Products session” or “Contact us” session) or call our worldwide technical support.

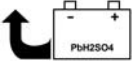
- Toll Free: 00 80011554499
- Toll Number Based in Italy: +39 0298250222

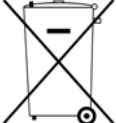

GLOSSARY OF SYMBOLS

	Risk of electrical shock
	Indicates a warning or a caution followed by important instructions
	AC input
	AC output
	Requests the user to consult the manual
	Indicates the unit contains a valve-regulated lead acid battery
	Recycle
	DC voltage
	Equipment grounding conductor
	Bonded to ground
	AC voltage
	WEEE

1.0 PRODUCT DESCRIPTION

The Liebert GXT4 is a compact, online uninterruptible power system (UPS) that continuously conditions and regulates its output voltage. The UPS is designed to supply microcomputers and other sensitive electronic equipment with clean sine wave input power, 700VA to 3000VA at 230V.

Upon generation, AC power is clean and stable. However, during transmission and distribution it is subject to voltage sags, spikes and complete failure that may interrupt computer operations, cause data loss and damage equipment.

The Liebert GXT4 protects equipment from these disturbances. The Liebert GXT4 continuously charges its batteries from the mains, enabling it to supply power to connected loads, even when the mains fail.

This section describes the UPS, its features, models, appearance and components, operating principles and operating mode.

1.1 Features

The UPS includes these features:

- Intelligent battery management to extend battery life
- LCD for user-friendly operation and local monitoring and configuration of operational parameters
- Flexible network management with Liebert MultiLink[®] software
- Fan fault self-inspection and automated diagnostic function
- Intelligent fan operation, automatically changing rotation speed depending on system requirements, to decrease power consumption and noise
- Input circuit breaker to ease recovery from overloads
- CE mark and safety approval from CE
- Communication options: USB port, Liebert IntelliSlot[®] port and terminal block communication
- Dry contacts for remote monitoring
- Input power factor greater than 0.99
- Output voltage selection function

1.2 Available Models

Available models of the UPS are listed in **Table 1**:

Table 1 UPS models, power ratings

Model	Nominal Power Rating
GXT4-700RT230 GXT4-700RT230E	700VA/630W
GXT4-1000RT230 GXT4-1000RT230E	1000VA/900W
GXT4-1500RT230 GXT4-1500RT230E	1500VA/1350W
GXT4-2000RT230 GXT4-2000RT230E	2000VA/1800W
GXT4-3000RT230 GXT4-3000RT230E	3000VA/2700W

1.3 Appearance and Components

1.3.1 Appearance

The Liebert GXT4 rack/tower models in various power ratings have the same general appearance, controls and features (see **Figure 1**). The various rack/tower models differ largely in the type of receptacles each has.

Figure 1 Liebert GXT4-700RT230 - GXT4-3000RT230 UPS



1.3.2 Rear Panel Features

The rear panel of the Liebert GXT4 has these features:

- Liebert IntelliSlot® Port
- USB port
- Input Circuit Breaker
- Input Receptacle
- General Output Receptacles
- Programmable Output Receptacles
- Cable Strain Relief Attachment Hole
- External Battery Connector
- Cooling Fan
- RS-232 port
- Terminal Block Communication
- Output Circuit Breakers (only on GXT4-3000RT230/230E models)

Figure 2 Rear components, Liebert GXT4 230V 700VA and 1000VA models

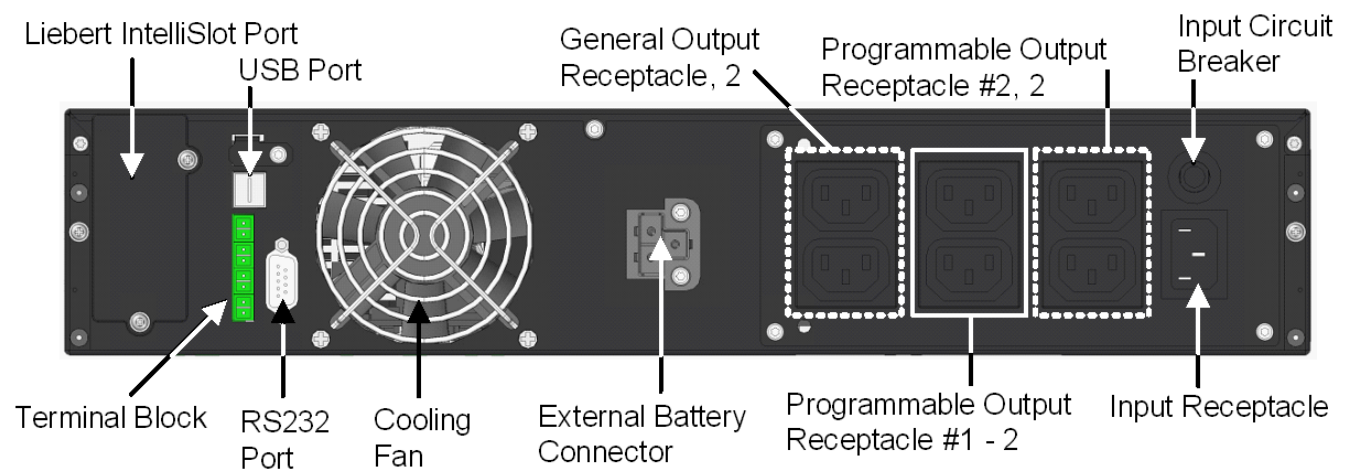

Figure 3 Rear components, Liebert GXT4 230V 1500VA models

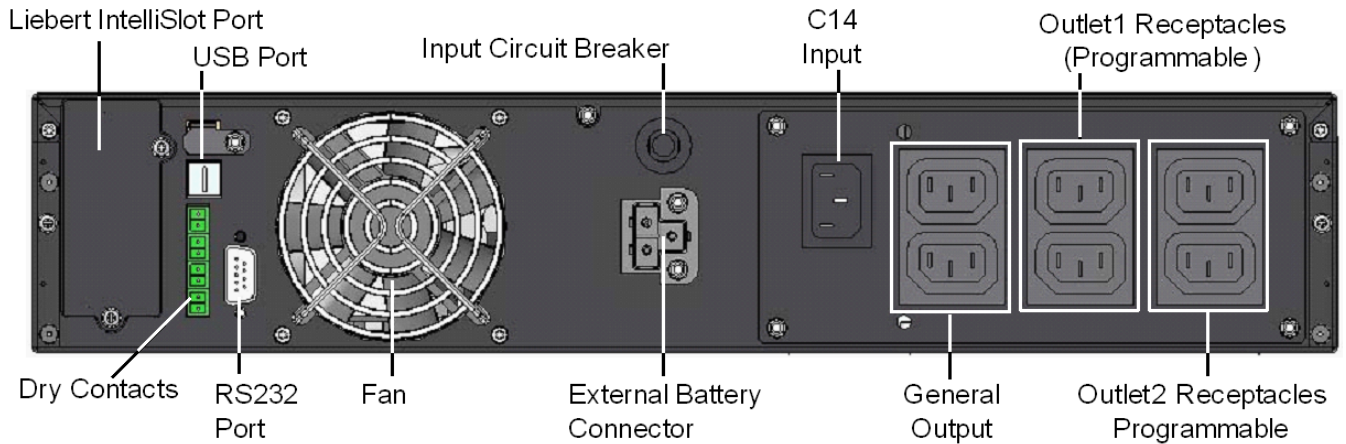

Figure 4 Rear components, Liebert GXT4 230V 2000VA models

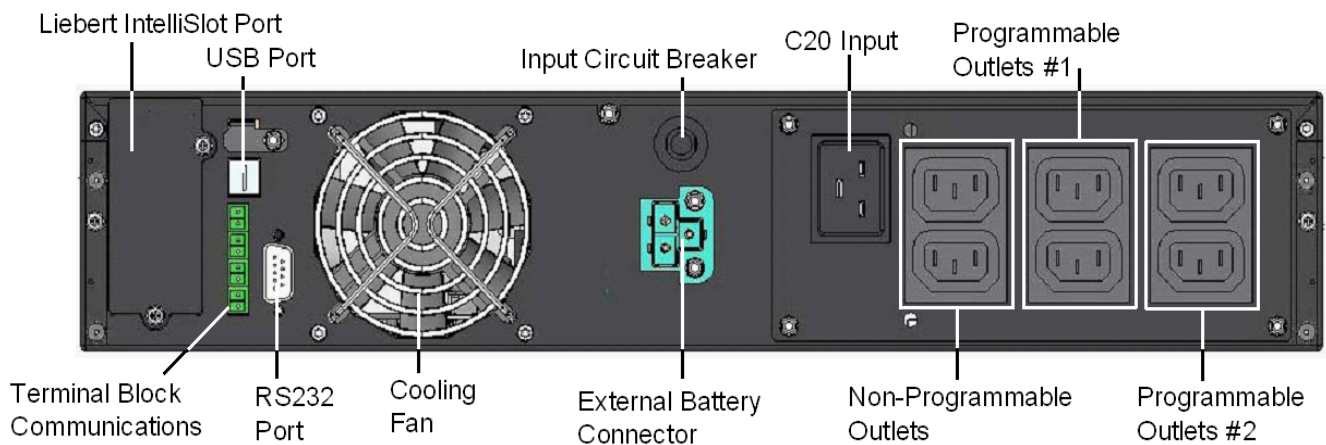
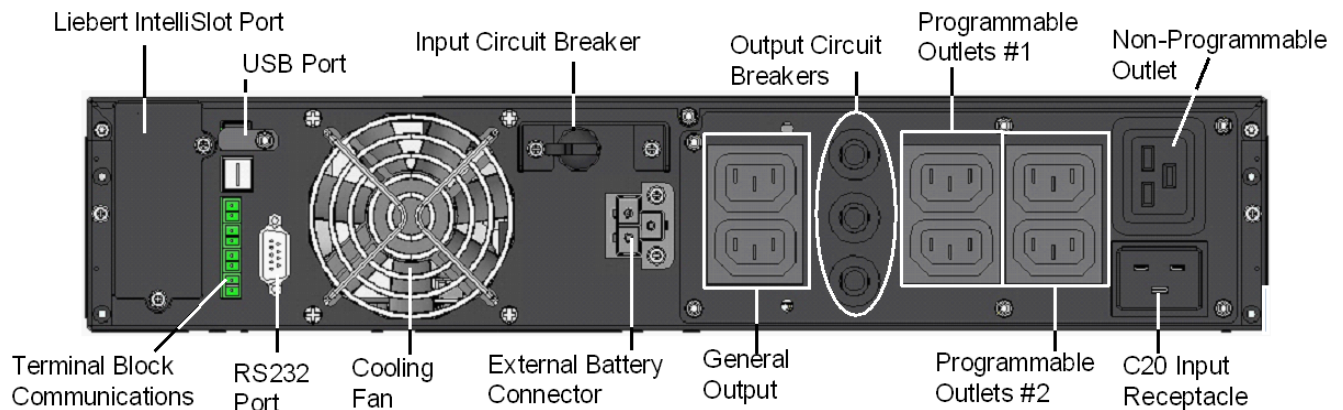

Figure 5 Rear components, Liebert GXT4 230V 3000VA models



1.4 Major Components

The operating principle of the UPS is shown in **Figure 6**.

Figure 6 Operating principle diagram

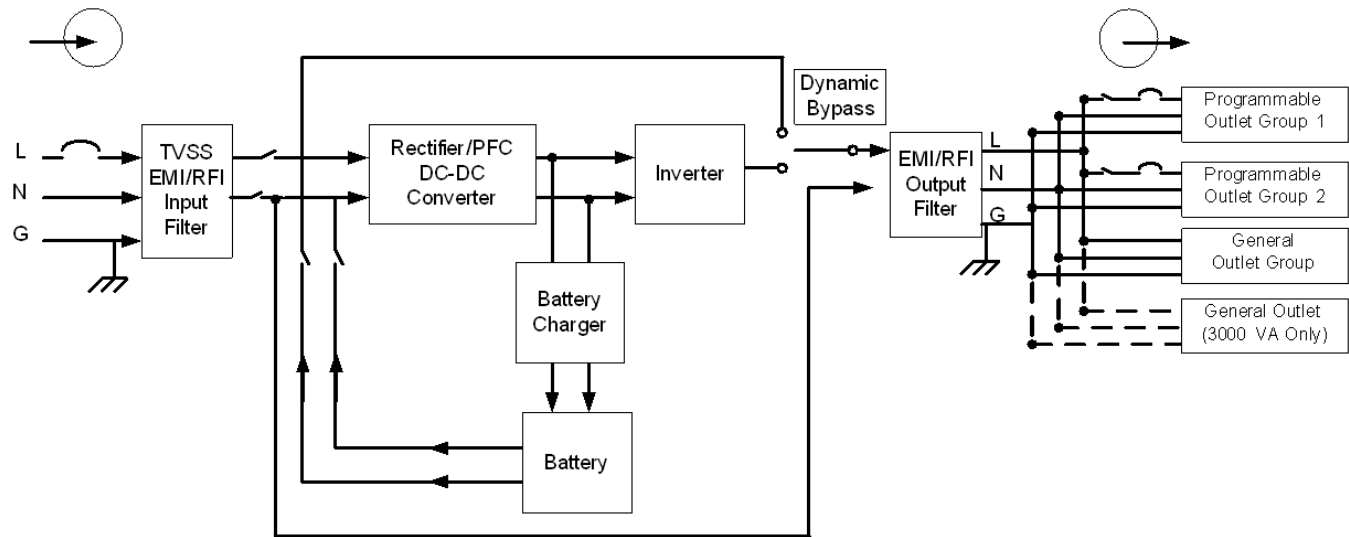

The UPS is composed of mains input, TVSS and EMI/RFI filters, rectifier/PFC, inverter, battery charger, DC-to-DC converter, battery, dynamic bypass and UPS output.

Transient Voltage Surge Suppression (TVSS) and EMI/RFI Filters

The Liebert GXT4 has surge protection and filters that protect the connected load from power surges and sags, electromagnetic interference (EMI) and radio frequency interference (RFI). These features can minimize any surges or interference present in the mains power. The filters also prevent surges or interference generated by the UPS from adversely affecting other devices connected on the same branch as the UPS.

Rectifier/Power Factor Correction (PFC) Circuit

In normal operation, the Liebert GXT4's rectifier/power factor correction (PFC) circuit converts mains power to regulated DC power for use by the inverter while ensuring that the wave shape of the input current used by the UPS is near ideal. Extracting this sine wave input current achieves two objectives:

- Efficient power use by the UPS
- Reduced reflected harmonics

This results in cleaner power being available to other devices in the building that are not protected by the UPS.

Inverter

In normal operation, the Liebert GXT4's inverter utilizes the DC output of the PFC circuit to produce precise, regulated sine wave AC power. When mains power fails, the inverter receives DC power from the battery through the DC-to DC converter. In either operation mode, the UPS inverter is online, continuously generating clean, precise, regulated AC output power.

Battery Charger

The battery charger utilizes energy from the mains power and precisely regulates it to continuously float charge the batteries. The batteries are being charged whenever the Liebert GXT4 is plugged in, even when the UPS is not turned On.

DC-to-DC Converter

The DC-to-DC converter raises the DC voltage from the battery to the optimum operating voltage for the inverter. This allows the inverter to operate continuously at its optimum efficiency and voltage, increasing reliability.

Battery

The Liebert GXT4 utilizes valve-regulated, nonspillable, lead acid batteries. To maintain battery design life, operate the Liebert GXT4 in an ambient temperature of 0°C to 25°C (32°F to 77°F).

Optional external battery cabinets are available to extend battery run times.

Dynamic Bypass

The Liebert GXT4 provides an alternate path for mains power to the connected loads in the unlikely event of a UPS malfunction. Should the Liebert GXT4 have an overload, overtemperature, or UPS failure condition, the UPS automatically transfers the connected loads to bypass.



NOTE

The bypass power path does not protect the connected loads from disturbances on the mains.

1.5 Operating Mode

The UPS operation modes include the following: Mains (AC) Mode, Bypass Mode, Battery Mode, Battery Recharge Mode, Active ECO Mode and Frequency Converter Mode.

Refer to **3.0 - Operation and Display Panel** for details about the operating mode indicators and control buttons.

1.5.1 Mains Mode

During Mains Mode, the mains provides input power to the Liebert GXT4. The filters, PFC circuit and inverter process this power to provide high-quality sine wave power to connected loads. The UPS maintains the batteries in a fully charged state.

1.5.2 Manual Bypass Mode

Manual Bypass Mode occurs when the unit is manually placed in internal bypass by navigating the LCD display menu to select *3 Control > 1 Turn On & Off > Turn UPS Bypass*. Bypass operation is indicated by an audible alarm and illuminated amber bypass indicator. (If other indicators are illuminated, refer to **7.0 - Troubleshooting**). During Bypass Mode, mains power bypasses the inverter and provides energy to the connected load.

NOTICE

Risk of loss of power to the connected load. Can cause equipment damage.

Turning Off the UPS in Bypass Mode will result in loss of output power to the connected load.

1.5.3 Battery Mode

The Liebert GXT4 enters Battery Mode when mains power fails or is outside acceptable limits. The battery system supplies power through the DC-to-DC converter to the inverter to generate clean AC power for the connected loads.

When the Liebert GXT4 enters Battery Mode, the UPS sounds a half-second beep at 10-second intervals. When approximately 2 minutes of run time remains, the beeps sound every 5 seconds to warn that the battery is getting low (this Low Battery Warning is user-configurable).

In Battery Mode, the battery indicator will illuminate and the LCD will show the prompt *Silence Alarm* and choices of *Yes* and *No*. The default is *No*. Press either the Up or Down arrow button to select *Yes*, then press the Enter button to silence the alarm.

Once the alarm prompt has been acknowledged, the UPS will display the estimated battery run time and battery capacity. Refer to **7.0 - Troubleshooting**. For approximate battery run times, refer to **Table 17**.

NOTICE

Risk of loss of power to the connected load. Can cause equipment damage.

Turning Off the Liebert GXT4 when it is in Battery Mode will result in loss of output power to the connected load.

If the UPS is turned Off manually, it must be manually restarted after mains power returns.

If the UPS is turned Off by a communication signal or because the batteries are depleted, it will operate as set in the configuration program for Auto-Restart (Refer to **5.2.1 - Configuration Program**).

1.5.4 Battery Recharge Mode

Once mains power is applied to the Liebert GXT4, the Battery Charger begins charging the batteries.

1.5.5 Frequency Converter Mode

All models of the Liebert GXT4 are capable of frequency conversion. Frequency Conversion Mode can be selected using the configuration program. Allowable frequency operating modes include:

- Auto Sensing - 50Hz or 60Hz – Bypass Enabled
- Auto Sensing - 50Hz or 60Hz – Bypass Disabled
- Frequency Converter - 50Hz – Bypass Disabled
- Frequency Converter - 60Hz – Bypass Disabled



NOTE

The default for all models of the Liebert GXT4 is “Auto Sensing - 50Hz or 60Hz – Bypass Enabled.”



CAUTION

Risk of electric shock. Can cause injury or death.

Never touch the AC input receptacle while the UPS is operating. Voltage may still be present even when the AC input indicator is Off.

1.5.6 Active ECO Mode

All Liebert GXT4 models can operate in Active ECO Mode. In this mode, the connected equipment is powered through the bypass path to increase efficiency, reducing the electrical costs.

Active ECO mode keeps the rectifier and inverter operating, allowing the inverter to remain synchronized to bypass. This synchronization allows the transfer of the connected equipment to UPS inverter power almost seamlessly if bypass power falls outside the user-set limits. Once bypass power returns within the acceptable parameters, the UPS will return to Active ECO Mode operation.

The default setting is Active ECO Mode Off.

2.0 INSTALLATION

2.1 Unpacking and Inspection

Unpack the UPS and conduct the following checks:

- Inspect the UPS for shipping damage. If any shipping damage is found, report it to the carrier and your local dealer or Emerson® representative immediately.
- Check the accessories against the delivery list. If there is any discrepancy, contact your local dealer or your Emerson representative immediately.

2.2 What's Included

- Terminal Block Communication Terminals
- Compact Disk with:
 - Liebert MultiLink® Shutdown Software
 - Configuration Program
 - User Manual
- USB Cable—one, 2m (6-1/2 ft.) long
- RS-232 Cable—one, 2m (6-1/2 ft.) long
- Cable Strain Relief—two pieces
- Rack mounting hardware, including screws, handles and mounting rail kit (not included with model numbers ending with an “E”)
- Plastic tower stand sets—two (four pieces)
- Warnings, Safety Instructions booklet and WEEE recycling sheet (ISO 14001 compliance)

With 700VA - 1500VA Units:

- 10A IEC C13 C14 Output Cable—two, 2m (6-1/2 ft.) long
- CEE 7/7 (Schuko) to IEC C13 input cord—one, 2.5m (8-1/2 ft.) long
- BS 1363 (UK) to IEC C13 input cord—one, 2.5m (8-1/2 ft.) long
- Australian type A to SAA input cord—one (not included with model numbers ending with “E”)

With 2000VA - 3000VA Units:

- 10A IEC C13 C14 Output Cable—three, 2m (6-1/2 ft.) long
- CEE 7/7 (Schuko) to IEC C20 Input Cable—one, 2.5m (8-1/5 ft.) long
- BS1363 (UK) to IEC C20 Input Cable—one, 2.5m (8-1/5 ft.) long
- Australian type A to SAA input cord—one (not included with model numbers ending with “E”)



NOTE

The GXT4 External Battery Cabinet shipping package includes one battery cabinet, two spacers for tower configuration and one DC power cable and rack mounting hardware, including screws, handles and mounting rail kit (not included with model numbers ending with an “E”).

2.3 Preparation for Installation

2.3.1 Installation Environment

- Install the UPS indoors in a controlled environment where it cannot be accidentally turned Off. The installation environment should meet the specifications in **9.0 - Specifications**.
- Place the UPS in an area where airflow around the unit is unrestricted and away from water, flammable liquids, gases, corrosives and conductive contaminants. Avoid direct sunlight.



NOTE

Operating the Liebert GXT4 in temperatures above 25°C (77°F) reduces battery life.

Installation Clearances

Maintain a clearance of at least 100mm (4 inches) in the front and rear of the Liebert GXT4. Do not obstruct the air inlets on the front panel or rear panel of the UPS—blocking the air inlets reduces ventilation and heat dissipation, shortening the service life of the Liebert GXT4.

2.4 Mechanical Installation

The Liebert GXT4 may be installed as a tower or in a rack, depending on space and use considerations. The Liebert GXT4 may be used alone, as a single UPS, or with up to six battery cabinets.



NOTE

When installing the UPS or making input and output connections, comply with all relevant safety codes and standards.

2.4.1 Tower Installation

To install the Liebert GXT4 as a tower:

1. Take the support bases from the accessories package (see **Figure 7**).

Figure 7 Support bases

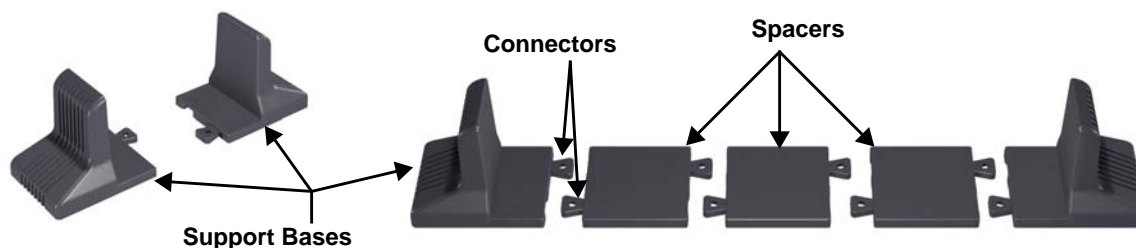

2. If optional Liebert external battery cabinets will be connected to the Liebert GXT4, take out the spacers delivered with the battery cabinet.
3. Connect the spacers and the support bases as shown in **Figure 7**. Each Liebert GXT4 needs two assembled support bases, one in the front and one in the rear.
4. Adjust the direction of the operation and display panel and logo on the Liebert GXT4.
 - a. Remove the front plastic bezel cover (see **Figure 8**).

Figure 8 Remove the front plastic bezel cover



- b. Pull the operation and display panel, rotate it 90 degrees clockwise and snap it back into position (see **Figure 8**).
 - c. Pull the logo on the front plastic bezel cover, rotate it 90 degrees clockwise and snap it back into position. The rotated front plastic bezel cover is shown in **Figure 9**.
 - d. Replace the front plastic bezel cover on the Liebert GXT4. At this point, the UPS operation and display panel and logo have been rotated 90 degrees clockwise, which provides upright viewing for users.
5. Place the Liebert GXT4 and any battery cabinets on the support bases. Each Liebert GXT4 needs four support bases, as shown in **Figure 9**.

Figure 9 Tower installation

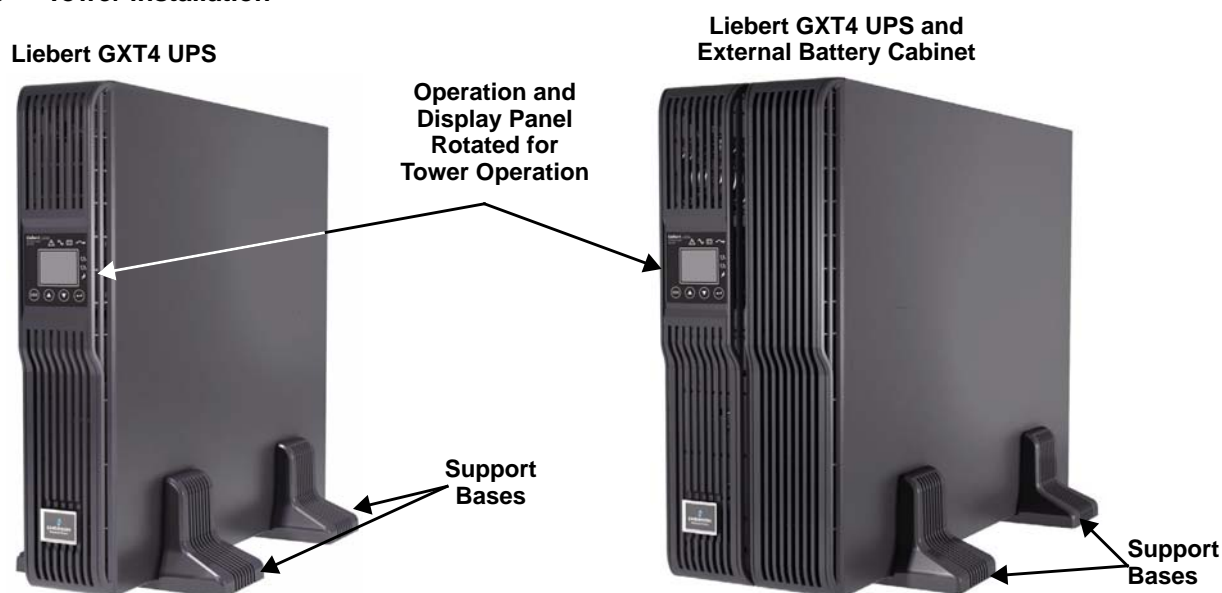

2.4.2 Rack Installation

The Liebert GXT4 UPS and external battery cabinets (EBC), when installed in a rack enclosure, must be supported by a shelf or rack-mount rails. The Liebert GXT4 UPS and EBC units ship with all required hardware to allow rack-mount installation (not included with model numbers that end in “E”). Because different rack-mount options install differently, refer to the installation instructions provided with the rack mount kit being used.

2.5 Cable Connection

The Liebert GXT4 rear panel has an input receptacle and output receptacles. Refer to **1.3.2 - Rear Panel Features** for details. The battery cables are supplied with the battery cabinet.

2.5.1 Connecting to AC Mains and Loads



NOTE

Ensure that all the loads are turned Off.

Prepare an input power supply that is properly protected by a circuit breaker in accordance with national and local electrical codes. The wall receptacle must be grounded.

Emerson® recommends installing an upstream circuit breaker of the same or higher rating as the Liebert GXT4's input circuit breaker.

The specification of input circuit breaker on the rear panel of the UPS is given in **Table 2**.

Table 2 Input circuit breaker specifications

Unit Rating	Circuit Breaker Rating
700-1500 VA Models	10A
2000-3000VA Models	16A

For North America Installations

Detachable Power Supply Cord Not Provided. Power Supply Cord Selection (for units which power supply cord not furnished with) - Use UL Listed detachable power supply cord, three conductors, minimum 4.5 ft. (1.5m), maximum 14.8 ft. (4.5m) long. Types SP-2, SP-3, SV and similar cords may be provided if the cord is not long. Refer to **Tables 3** and **4** for details.

Table 3 Type of cord

UPS Model	Type of Cord
GXT4-700RT230, GXT4-700RT230E GXT4-1000RT230, GXT4-1000RT230E GXT4-3000RT230, GXT4-3000RT230E	SVE, SVO, SVOO, SVT, SVTO, SVTOO, SPE-2, SPT-2, NISP-2, NISPE-2, NISPT-2, SPE-3, SPT-3, SJ, SJE, SJO, SJOO, SJT, SJTO, SJTOO, S, SE, SO, SOO, ST, STO, STOO

Table 4 Ratings of cord

UPS Model	Minimum Wire Gauge	Minimum Cord Ratings	Attachment Plug Ratings
GXT4-3000RT230 GXT4-3000RT230E	12 AWG/3C	250 V, 105°C, VW-1	20 A, +250V (NEMA L6-20P)
GXT4-700RT230 GXT4-700RT230E GXT4-1000RT230 GXT4-1000RT230E	16 AWG/3C	250 V, 105°C, VW-1	15 A, +250V (NEMA L6-15P)

Liebert GXT4 models 700-1500VA and 2000VA have three groups of outlets as shown in **Figures 2, 3** and **5**. One group is always On; the other two groups may be controlled with either programmed responses or over an SNMP network. The 3000VA GXT4 UPS has four groups of outlets: two groups are not controlled (always On), and two groups may be controlled with either programmed responses or over an SNMP network.

Verify that the equipment is plugged into the appropriate outlets if any outlets will be controlled with these features.

1. Plug equipment into the appropriate output receptacles on the rear of the Liebert GXT4.



NOTE

1. Do not overload any output receptacle.
 2. Output cable length should not exceed 10m (32.8 ft).
2. Plug the input receptacle of the Liebert GXT4 into the input power connection.
 3. Install the two cable strain relief fixtures to secure either the input or output cables to prevent accidental disconnection.
 - a. Insert one end into the provided holes on the rear of the unit.
 - b. Place the power cord(s) inside the loop.
 - c. Tighten the loop around the cables.

Figure 10 Cable strain relief



2.5.2 Connecting Battery Cables

1. Verify that the battery isolation breaker is in the Off (open) position.
2. Take out the battery cable included with the battery cabinet.
3. Connect one end of the battery cable to the external battery connector on the rear panel of the UPS, and connect the other end to any battery port on the rear panel of the battery cabinet.
4. Repeat **Steps 1** through **3** for each battery cabinet that will be connected to the system. Additional battery cabinets will plug into the previously installed battery cabinet.
5. Switch On the battery breaker on the rear of the external battery cabinet.
6. Use the configuration program included with the UPS to specify the number of external battery cabinets connected to the Liebert GXT4. See **Table 17** for approximate battery run times.

Figure 11 Battery cable attachment

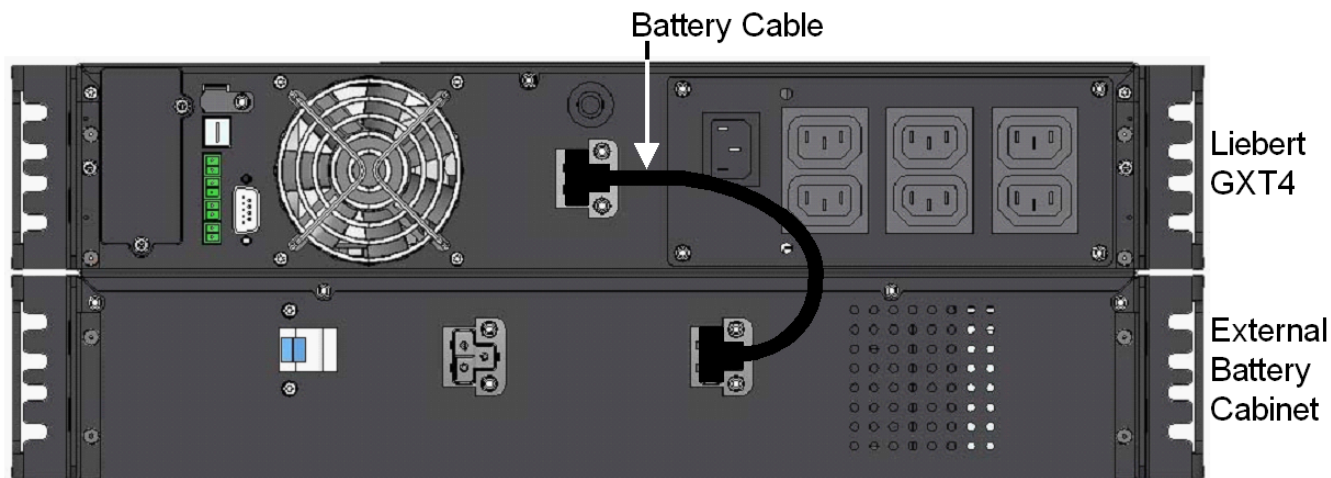

2.6 Connecting Communication Cables

Communication cable connection includes USB and optional card cables.

2.6.1 Connecting USB Communication Cables

1. Remove the USB communication cables from the accessories bag.
2. Insert one end of the USB communication cable to the USB port on the rear panel of the Liebert GXT4 (see **Figure 2**).
3. Insert the other end of the USB communication cable to the USB port of the computer.

2.6.2 Installing the Optional Liebert IntelliSlot® Card and Communication Cables

1. Remove the protective cover from the Liebert IntelliSlot port on the Liebert GXT4 and set it aside.
2. Insert the Liebert IntelliSlot card into the Liebert IntelliSlot port and secure it with screws.
3. To connect any cable associated with a Liebert IntelliSlot card, refer to the user manual provided with the card.

To configure and use the Liebert IntelliSlot communication card, refer to the card's user manual. Manuals for the various Liebert IntelliSlot cards are available at Liebert's Web site:

www.liebert.com

3.0 OPERATION AND DISPLAY PANEL

This chapter describes the Liebert GXT4 controls, particularly the operation and display panel on the front of the Liebert GXT4. The panel has four control buttons, seven LED indicators and a liquid crystal display (LCD), as shown in **Figure 12**.

Figure 12 Operation and display panel

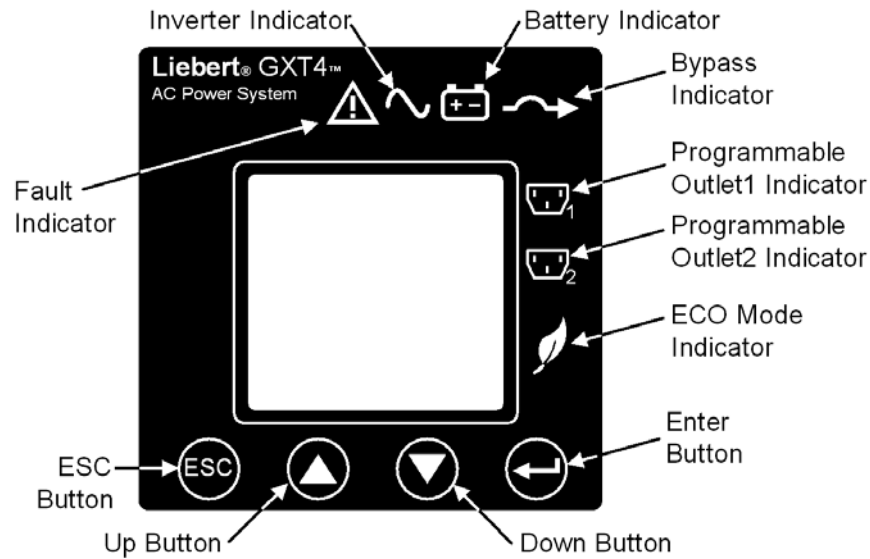

3.1 LED Indicators

The seven LED indicators on the front of the operation and display panel are:

- Inverter
- Battery
- Bypass
- Programmable Outlet1
- Programmable Outlet2
- ECO Mode
- Fault

Figure 12 shows the indicators' locations; their descriptions and functions are shown in **Table 3**.

Table 3 LED indicators

LED Indicators	LED Color	Description
Inverter	Green	On when the inverter is supplying power
Bypass	Amber	On when the load is supplied by the mains through automatic/manual bypass
Battery	Amber	On when the load is supplied by the battery
Fault	Red	On when an error has occurred within the UPS
Programmable Outlet1	Green	On when programmable Outlet1 is On
Programmable Outlet2	Green	On when programmable Outlet2 is On
ECO Mode	Green	On when the UPS is in ECO Mode

3.2 Control Buttons

The four control buttons on the front of the operation and display panel are:

- ESC
- Up
- Down
- Enter

Figure 12 shows the buttons' locations; their descriptions and functions are shown in **Table 4**.

Table 4 Control buttons

Control Buttons	Description
ESC Button	Pressing this button returns to the previous menu or aborts any change in the input data field before confirming.
Up Button	Pressing this button can move the cursor up or increase the value displayed in the input data field. When a menu is displayed on several screens, pressing the button can scroll up.
Down Button	Pressing this button can move the cursor down or decrease the value displayed in the input data field. When a menu is displayed on several screens, pressing the button can scroll down.
Enter Button	Pressing this button can enter the next level menu or confirm the parameter setting value.

3.3 LCD

The LCD panel shows the UPS status and enables changes to the UPS settings by assisting in navigating through the Liebert GXT4's menu (see **3.4 - Menu Structure**).

3.4 Menu Structure

The menu structure of the LCD is shown in **Figure 13**.

Figure 13 Menu structure

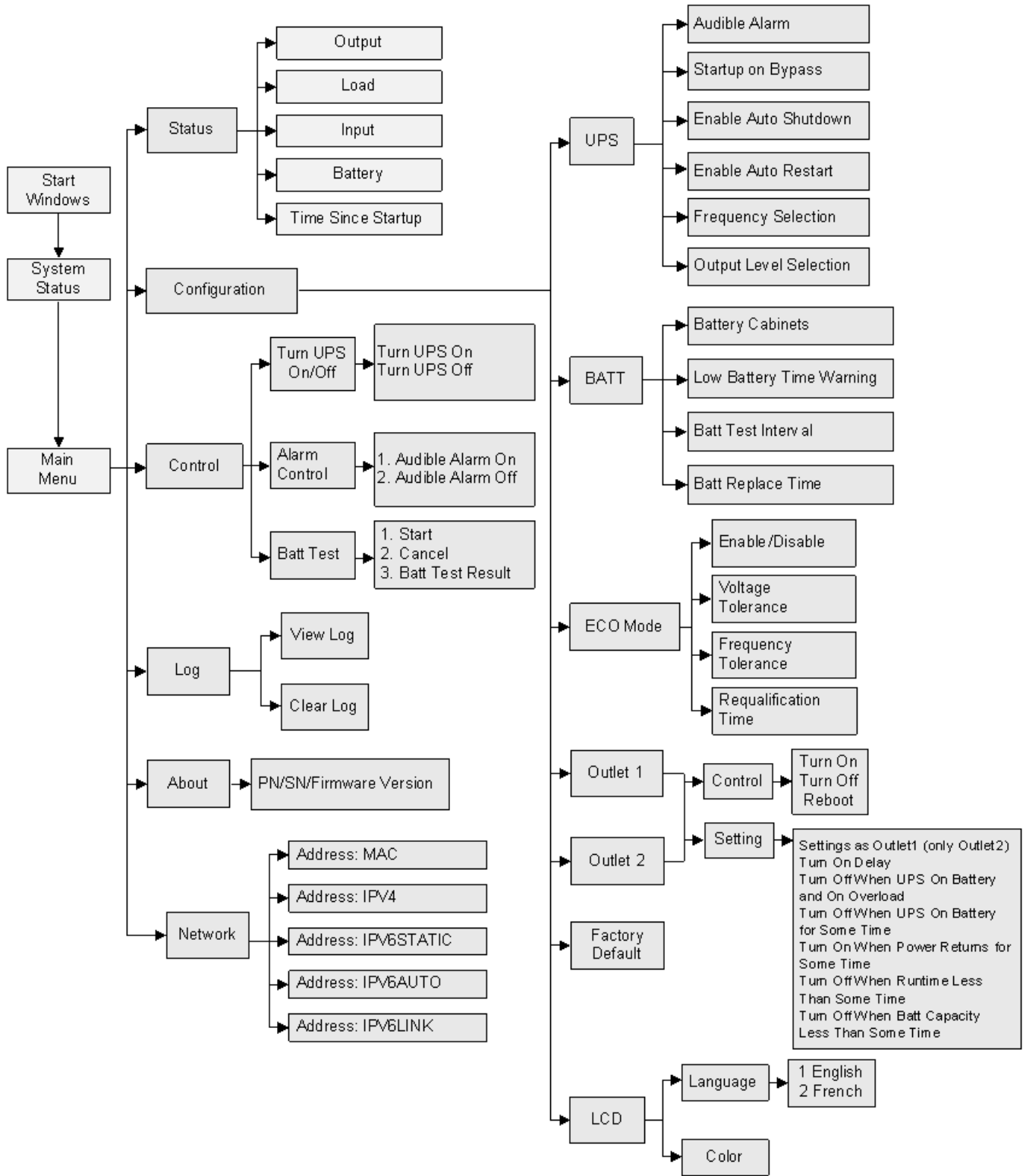

3.4.1 Startup Screen

When the Liebert GXT4 is starting up, it initiates a self-test and displays the screen shown in **Figure 14** for about 10 seconds.

Figure 14 Startup screen



After about 10 seconds, the LCD shows one of the On screens in **Figure 15**; the screen shown depends on whether input power is available.

Figure 15 Startup screens

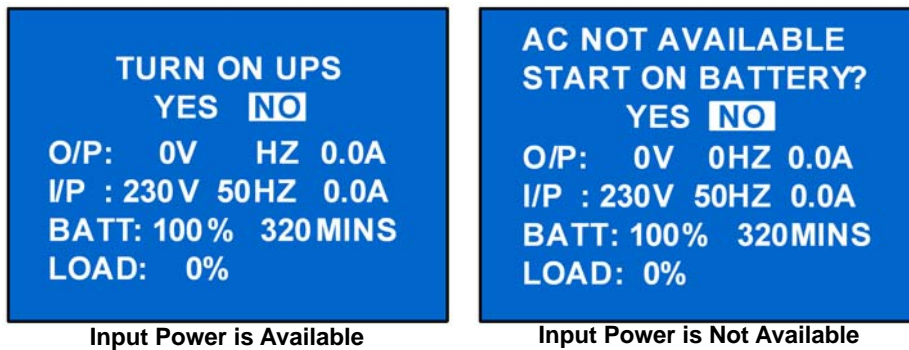

To turn on the UPS, press either the Up or Down button to select *YES* and press the Enter button. The UPS will start up, the LCD will display *UPS STARTING* and then *START SUCCESSFUL* after the UPS is turned On, as shown in **Figure 16**.

Figure 16 Starting and Start Successful screens



3.4.2 Default Screen

Press any button in the START SUCCESSFUL screen to enter the default interface, shown in **Figure 17**.

Figure 17 Default screen

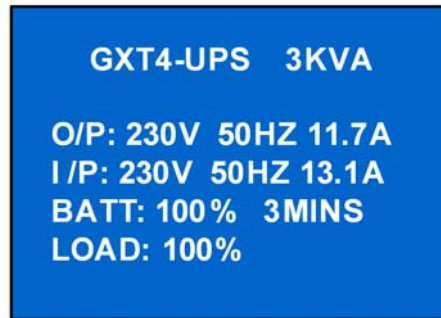

Values shown will vary according to installation and configuration.

In the default screen, the LCD shows the UPS model, output parameters, input parameters, battery capacity with run time estimate and load percentage. The UPS operation mode (online /inverter, ECO, Battery or Bypass) will be indicated by the LED indicators.

If no control button (ESC, Up, Down, Enter) is pressed for 2 minutes, the LCD will enter the screen saver mode (backlight turns off). It will remain off until a control button is pressed.

3.4.3 Main Menu Screen

Press the Enter button in the default screen to enter the MAIN MENU screen, as shown in **Figure 18**.

Figure 18 Main Menu screen

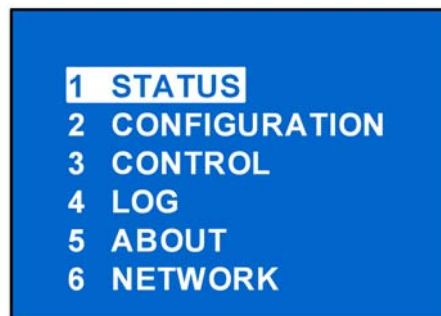

To select a submenu, press the Up or Down button to move the cursor to the required item, then press the Enter button to enter its submenu or set its parameter.

STATUS Screen

In the MAIN MENU screen, select *STATUS* to enter the Status Screen, displaying OUTPUT, LOAD, INPUT, BATTERY and TIME SINCE STARTUP, as shown in **Figure 19**.

Figure 19 Status screens

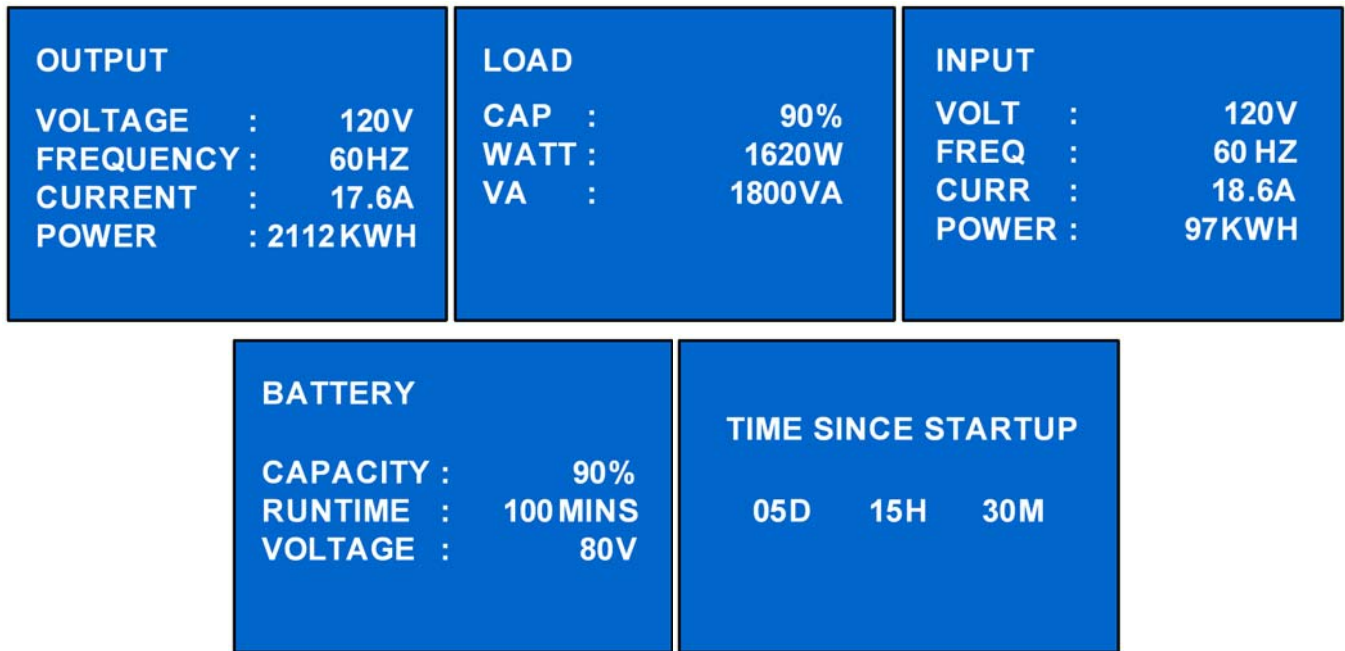

CONFIGURATION Screen

Select *MAIN MENU* > *CONFIGURATION* to enter the Configuration menu. This menu has seven submenus, as shown in **Figure 20**.

Figure 20 CONFIGURATION screen

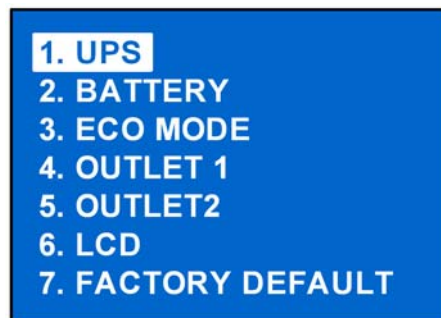

In the CONFIGURATION screen, press the Up or Down button to move the cursor to the required item, then press the Enter button to enter a submenu or set its parameters.

UPS Screen

Select *MAIN MENU > CONFIGURATION > UPS* to enter the UPS screen. This menu has six screens, as shown in **Figure 21**.

Figure 21 UPS screens

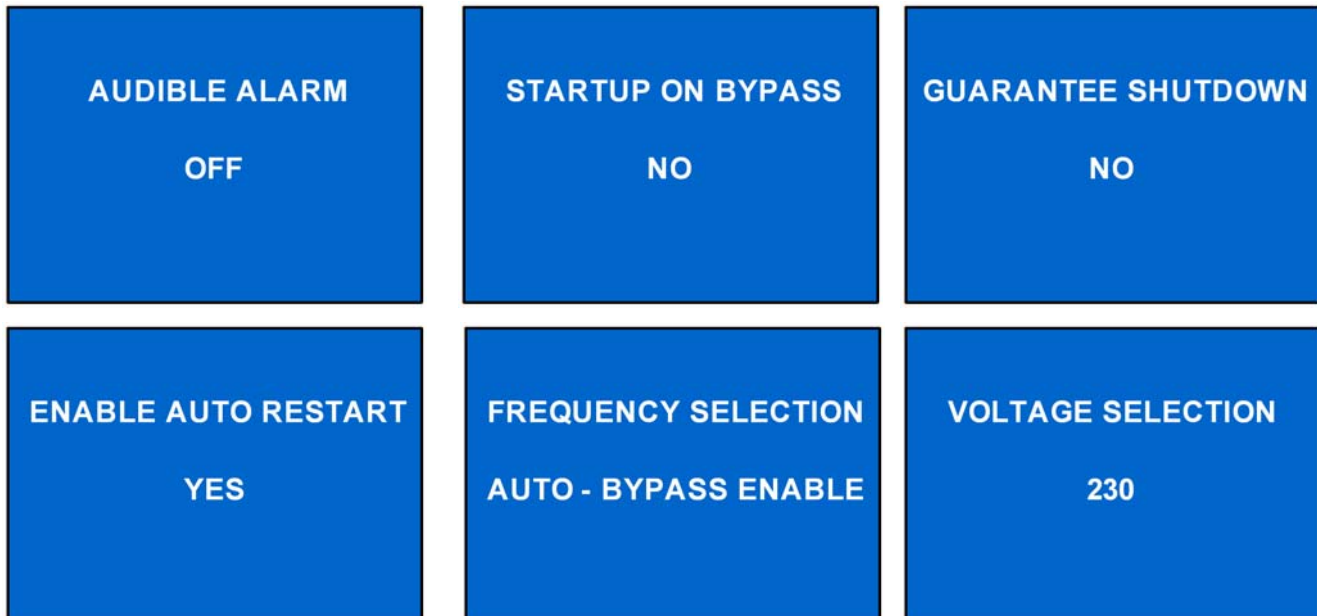

Press the Up or Down button to move the cursor to the required item, and press the Enter button to confirm the settings.

Battery Screen

Select *MAIN MENU > CONFIGURATION > BATTERY* to enter the BATTERY screen. This menu has four screens, as shown in **Figure 22**.

Figure 22 Battery screen

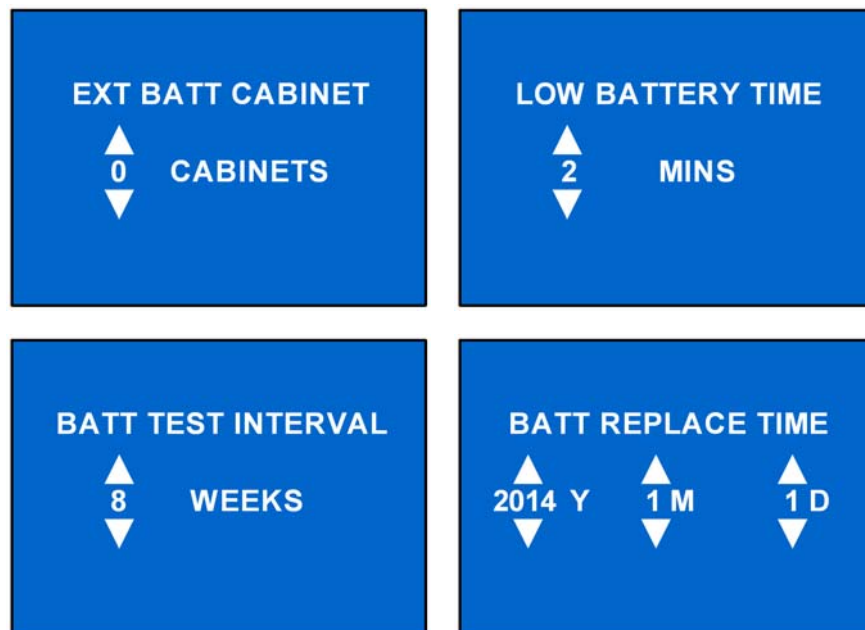

Press the Up or Down button to increase or decrease the value of the settings, and press the Enter button to confirm it.

ECO Mode Screens

Select *MAIN MENU > CONFIGURATION > ECO MODE* to enter the ECO MODE screens, as shown in **Figure 23**.

Figure 23 ECO Mode screen

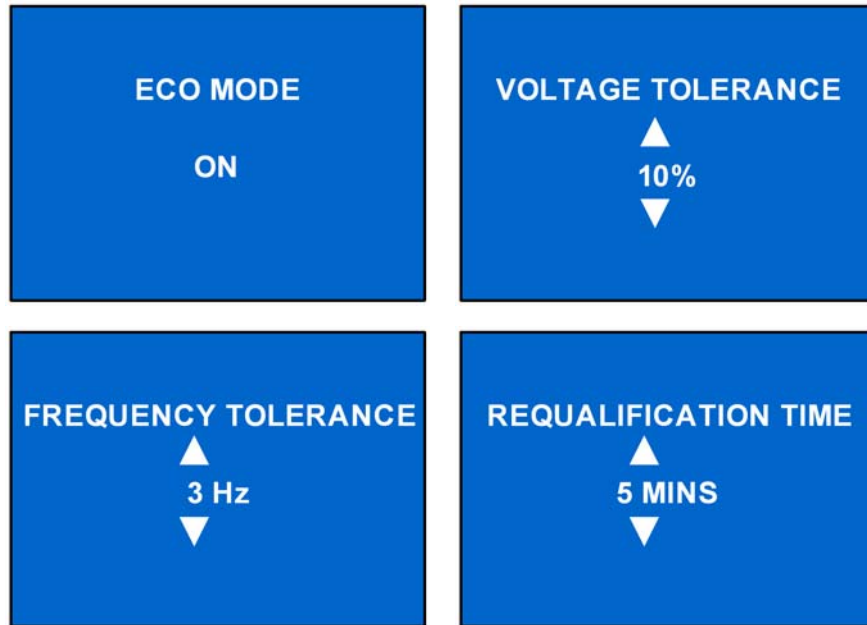

Press the Up or Down button to move the cursor to the required item, and press the Enter button to confirm the settings.

Outlet1 Screen

Select *MAIN MENU > 2 CONFIGURATION > 4 OUTLET1* to enter the OUTLET1 screen. This menu has two submenus, as shown in **Figure 24**.

Figure 24 Outlet1 screen



Select 1 *OUTLET CONTROL* and press the Enter button to enter the *OUTLET CONTROL* screen, as shown in **Figure 25**.

Figure 25 Outlet Control screen

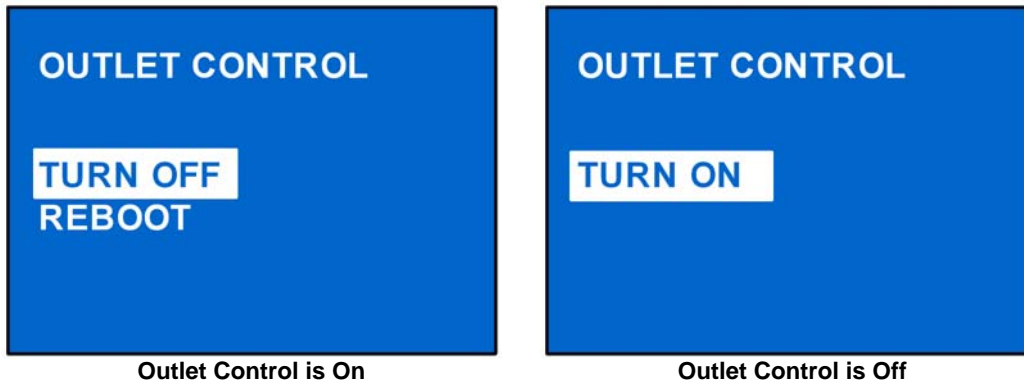

Press the Up or Down button to move the cursor to the required item, and press the Enter button to confirm the settings.

Select 2 *Outlet Setting* and press the Enter button to enter the *OUTLET SETTING* screen, as shown in **Figure 26**.

Figure 26 Outlet Setting screen

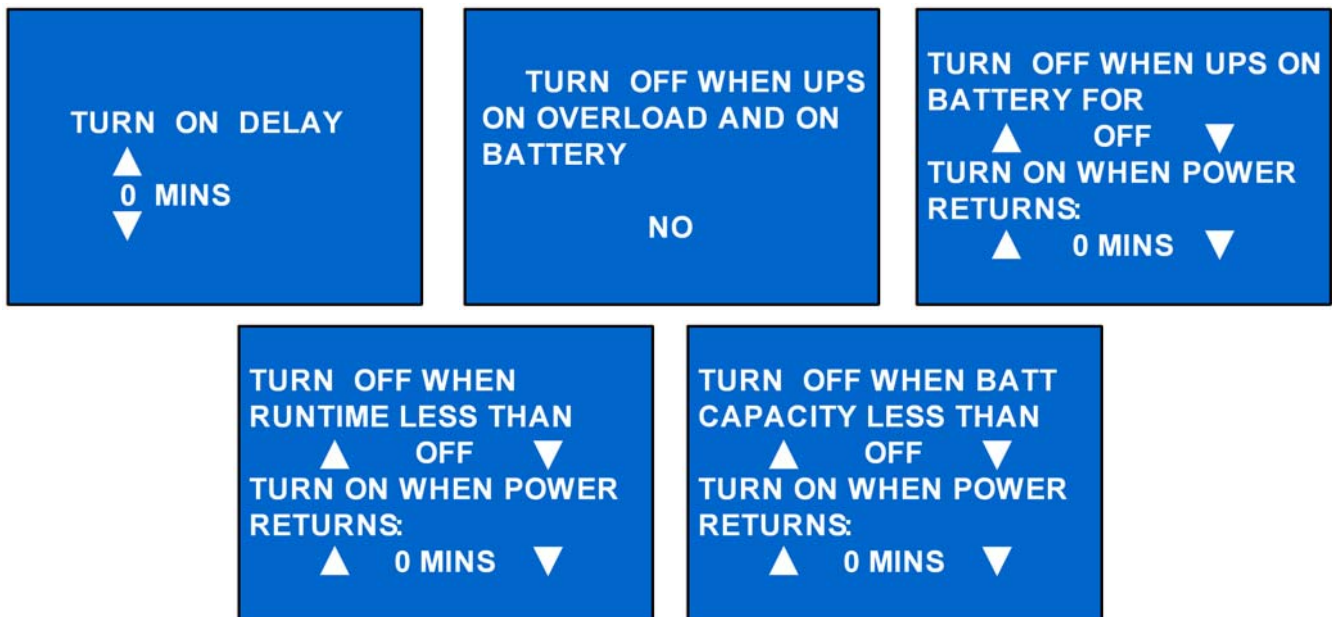

Press the Up or Down button to move the cursor to the required item, and press the Enter button to confirm the settings.

Outlet2 Screen

The Outlet2 screens are the same as the Outlet1 screens. The same settings are available as on the Outlet1 screen. If the Outlet2 group will have the same settings as the Outlet1 group, the Liebert GXT4 offers a programming shortcut, as shown in **Figure 27**. When configuring the Outlet2 group, the select *YES* and press the Enter button to apply the Outlet1 settings to the Outlet2 screen.

Figure 27 Outlet2 setting screen



LCD screen

Select Main Menu -> **2 CONFIGURATION** -> **6 LCD** to enter the LCD screen. This menu has two submenus, as shown in **Figure 28**.

Figure 28 LCD screen



Select *1 LANGUAGE* and press the Enter button to enter the LANGUAGE screen, as shown in **Figure 29**.

The Liebert GXT4 is capable of supporting multiple languages. For the list of supported languages and instructions on how to upload them, refer to the Configuration Program user manual on the included CD.

Figure 29 Language screen



Select *2 COLOR* and press the Enter button to enter the COLOR screen, as shown in **Figure 30**.

Figure 30 Color screen

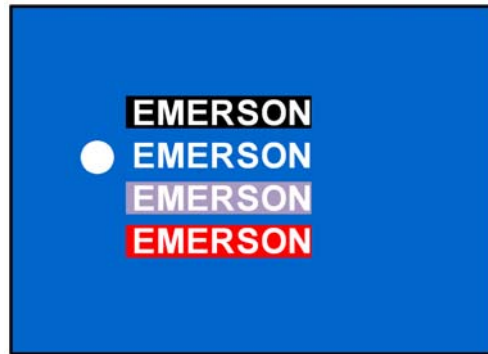

FACTORY DEFAULT screen

Select *MAIN MENU* -> *2 CONFIGURATION* -> *7 FACTORY DEFAULT* to enter the FACTORY DEFAULT screen, as shown in **Figure 31**.

Figure 31 Factory Default screen



Control Screen

Select *MAIN MENU* -> *3 CONTROL* to enter the CONTROL screen. This screen has three submenus, as shown in **Figure 32**.

Figure 32 Control screen



In the CONTROL screen, press the Up or Down button to move the cursor to the required item, and press the Enter button to enter its submenu.

TURN ON & OFF screen

Select *MAIN MENU* -> *3 CONTROL* -> *1 TURN ON & OFF* to enter the TURN ON & OFF screen. This screen shows one of two displays, depending on the state of the UPS, as shown in **Figure 33**.

Figure 33 Turn UPS On or Off screen

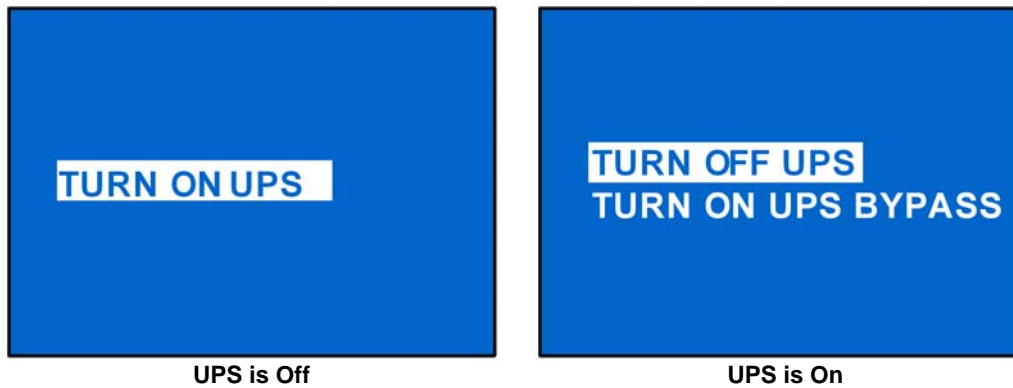
**ALARM CONTROL screen**

Select *MAIN MENU* -> *3 CONTROL* -> *2 ALARM CONTROL* to enter the ALARM CONTROL screen, as shown in **Figure 34**. This section allows active audible alarms to be silenced. To completely turn off the audible alarm, refer to *CONFIGURATION > UPS* as shown in **Figure 21**.

Figure 34 Alarm Control screen

**BATT TEST screen**

Select *MAIN MENU* -> *3 CONTROL* -> *3 BATT TEST* to enter the BATT TEST screen, as shown in **Figure 35**.

Figure 35 Batt Test screen

**Log Screen**

Select *MAIN MENU* -> *4 LOG* to enter the LOG screen. This screen has two submenus, as shown in **Figure 36**.

Figure 36 Log screens

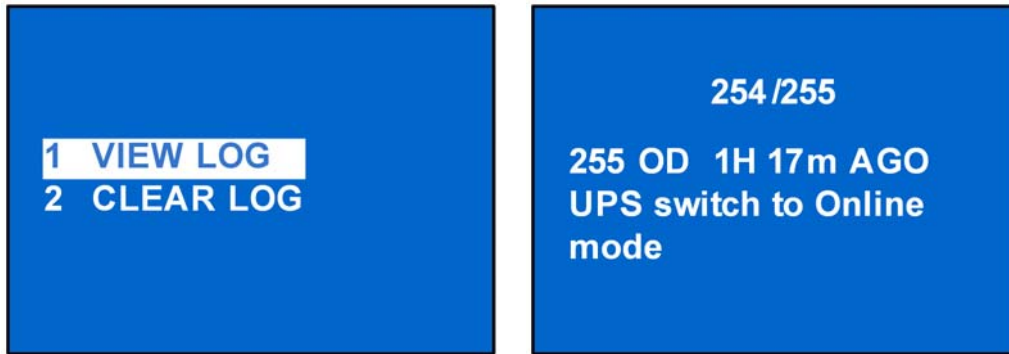
**CLEAR LOG Screen**

Select *MAIN MENU > LOG > CLEAR LOG* to enter the CLEAR LOG screen, as shown in **Figure 37**.

Figure 37 Clear Log screen

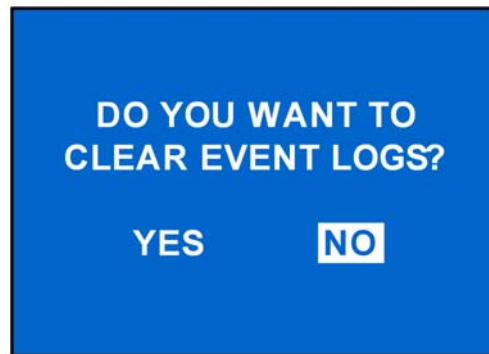

Press the Up or Down button to move the cursor to the required item. Press the Enter button to confirm the settings.

ABOUT Screen

Select *MAIN MENU > ABOUT* to enter the ABOUT screen, as shown in **Figure 38**.

Figure 38 About screen



The ABOUT screen displays UPS model, serial number, software version and hardware version.

Network

Select *MAIN MENU > NETWORK* to enter the NETWORK screen.

The NETWORK screen displays the MAC address and the IPv4 IP address. If the Liebert GXT4 is fitted with an optional Liebert IntelliSlot Web card (Liebert IS-WBCARD), the screen will display IPv6 IP address settings (IPv6 requires configuration), as shown in **Figure 39**.

Figure 39 Network screens

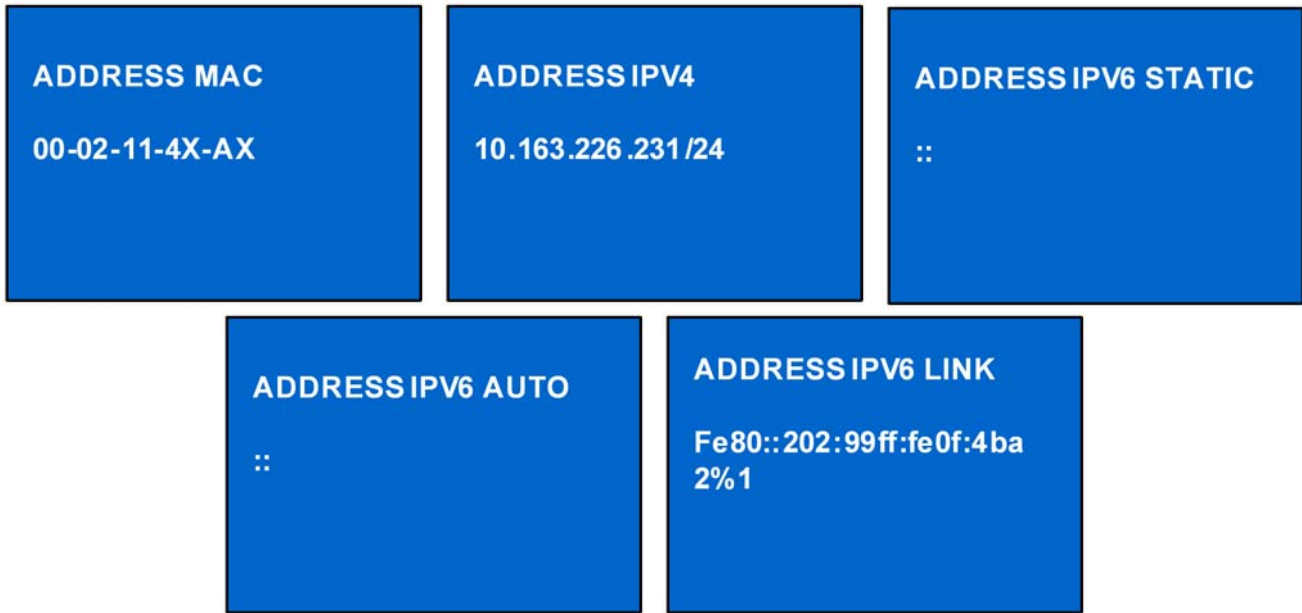

3.4.4 Prompt List

A prompt screen is displayed during the operation of the system to alert you to certain conditions and/or to require your confirmation of a command or other operation. See **Table 5** for the system prompts and meanings.

Table 5 Prompts and meanings

Prompt	Meanings
Mains Power Restored	The mains power returns and the UPS transfers back to mains (AC) mode.
UPS Return From A Low Battery Condition	The UPS transfers back to mains (AC) mode from battery low mode.
UPS Return From Battery Mode	The UPS transfers back to mains (AC) mode from battery mode.
UPS Self Test Successful	The UPS self-test is successfully performed.
UPS Shutdown Command Received	The UPS shut down was initiated through communication.
UPS Turn Off	The UPS shuts down and has no output power.
UPS Turn On	The UPS starts up successfully and supplies protected power to the load.
UPS Shutdown Process Had Been Cancelled	The shutdown command sent through Liebert MultiLink or SNMP card to the UPS is canceled,
ECO Mode Enabled	The UPS is configured to ECO mode operation,
ECO Mode Disabled	The UPS is configured to Online mode, supplying protected power to the load through the inverter.
UPS Internal Temperature Return To Normal	The internal temperature of the UPS recovers to normal range.
UPS Load Return From Overload	The loads are reduced, and the UPS recovers to normal state from overload.
Load On Inverter	The inverter is on and supplies protected power to the load.
Load On ECO Bypass	The UPS is on ECO mode; the mains is supplying power to the load directly to reduce energy usage.
OUTLET1 Closed Auto / Manual	The programmable output receptacle 1 received a turn-off command and is turned Off.
OUTLET1 Open Auto / Manual	The programmable output receptacle 1 received a Turn-On command and is turned On
OUTLET2 Closed Auto / Manual	The programmable output receptacle 2 received a Turn-Off command and is turned Off.
OUTLET2 Open Auto / Manual	The programmable output receptacle 2 received a turn-on command and is turned On.
Bypass Power Restored	The bypass power recovered and the UPS can now transfer to bypass.

3.4.5 Warning List

All UPS warning messages are described in **Table 6**.

Table 6 Warning list

Warning	Description
Mains Power Not Available	The mains power is not available, or it cannot satisfy the input requirements for the UPS to operate from mains power
UPS Batteries Low And Exhausted Soon	The battery capacity is low and will be exhausted soon
UPS Has Switched To Battery Mode	The mains power is abnormal or the PFC side is faulty, the UPS transfers back to Battery mode
Load On Bypass	The UPS transfers to Bypass mode, at this point, the input mains power supplies power to the load directly, and the load is not protected
Input Power Wiring Error	L-N line reverse or PE not connected.
Bypass Power Not Available	The bypass power is not available, or it cannot satisfy the requirements for the UPS transfers to bypass
UPS Maintenance Bypass Output	The UPS transfers to maintenance bypass.

3.4.6 Fault List

All UPS fault messages are described in **Table 7**.

Table 7 Fault list

Fault	Description
UPS Self-Test Failed	The battery is bad or weak or not connected.
UPS Overload	The UPS is overloaded.
Inverter Out Of Order	The inverter has failed.
Battery Weak/Bad	The battery is bad or weak.
Output Short Circuit	The output connection is short-circuited.
DC Bus Overvoltage	The DC bus is faulty.
UPS Overtemperature	Overtemperature occurs to the UPS and the UPS will transfer to Bypass mode.
Charger Out Of Order	The charger has failed.
Fan Out Of Order	At least one fan is failed.
DC Bus Discharge Fail	DC-DC failure occurs.
Rectifier Out Of Order	Rectifier failure occurs.

If a fault occurs, the UPS automatically switches to Bypass Mode. The original operating mode will be maintained only in the case of a battery disconnection fault. The fault message alternates with UPS Mode once a second, the red fault indicator on the operation and display panel lights up and the alarm sounds continuously.

If a fault occurs, proceed as follows:

1. Enter the ALARM CONTROL screen (see **Figure 34**), and select *AUDIBLE ALARM ON* or *AUDIBLE ALARM OFF* to switch the alarm On or Off.
2. Enter the EVENT LOG screen (see **Figure 36**), and select *VIEW LOG* to view the entire Event log.



NOTE

There will be a short delay before the EVENT LOG screen displays the historical fault log to allow the log to load.

4.0 OPERATION

This section describes checks to be made before starting the UPS, how to start the UPS, manual battery test, manual bypass, shutting down the UPS and disconnecting mains power from the UPS.



NOTE

The Liebert GXT4's battery has been fully charged before delivery, but some charge will be lost during storage and shipping. To ensure that the battery has adequate reserve power to protect the connected load, charge the battery for three hours before putting the UPS into service.

4.1 Startup Checklist for the Liebert GXT4

Before starting the UPS, perform these checks:

- ___ 1. Check that the input plugs and loads are connected properly and reliably.
- ___ 2. Check that the battery cable is connected properly.
- ___ 3. Check that the communication cables are connected properly.

4.2 Starting the UPS

1. Plug the UPS into the appropriate AC outlet.
2. **3000VA models only**—Close the input breaker on the rear of the unit.
3. The UPS will begin the startup sequence once AC power is present.



NOTE

The UPS will sound an audible alarmist is normal

4. On the LCD, press either the Up or Down button once, then press the Enter button to turn on the UPS. The UPS will sound the audible alarm again when the output receptacles are being supplied by the internal bypass. It will sound one more time as the inverter powers the connected equipment.
5. Check the LCD and LED indicators to ensure the UPS is operating normally.
6. Check the load percentage on the default screen to ensure the connected equipment is not exceeding the UPS rated capacity.

The UPS is now providing conditioned power to the connected load.

4.3 Manual Battery Test

To initiate a manual battery test, select *MAIN MENU > CONTROL>BATT TEST>START*.

- If the battery test results show *FAILED*, allow the UPS to recharge the batteries for 24 hours.
- Retest the batteries after 24 hours of charging.
- After the batteries have been retested, if the battery test still shows *FAILED*, contact your local Emerson[®] representative or Emerson Network Power Channel Support.

4.4 Manual Bypass

To manually transfer the connected equipment to the internal bypass:

1. From the main menu select *CONTROL*, then press Enter.
2. Select *TURN ON & OFF* and press Enter.
3. Select *TURN UPS BYPASS* and press Enter. The UPS will transfer the connected loads to the internal bypass.

If the internal bypass is not available because of mains power problems, pressing this button once will be ignored. Bypass operation is indicated by an audible alarm and illuminated amber Bypass indicator. (If other indicators are illuminated, refer to **7.0 - Troubleshooting**.)

4.5 Shut Down the Liebert GXT4

To shut down the UPS from the LCD:

1. From the Main Menu select CONTROL, press Enter, then select TURN ON & OFF.
2. Press the enter key.
3. Select TURN UPS OFF, then press Enter.
4. Press either the Up or Down button to move the cursor to confirm the shutdown command and press Enter. The UPS will sound an audible alarm; this is normal.
Power to the connected equipment is now Off.
5. The UPS display will still be illuminated because the batteries are still being charged.

The UPS display will still be illuminated because the batteries are still being charged. The UPS may now be disconnected from AC power, and the UPS will completely shut down in approximately 15 seconds.

4.6 Disconnecting Input Power from the Liebert GXT4

1. After the UPS has been shut down as detailed in **4.5 - Shut Down the Liebert GXT4**, disconnect the input cable from the wall socket.
2. Wait 30 seconds and verify that all indicators have turned Off and the fan has stopped; this indicates that the power-off is complete.
3. Turn the external battery cabinet breaker switch to the Off position if the UPS has an external battery cabinet.

After powering Off the UPS, the UPS ceases output and the load is powered Off.

5.0 COMMUNICATION

This section describes the four types of communication ports on the rear of the UPS:

- Liebert IntelliSlot® port
- USB port (standard B-type)
- Terminal Block Communication
- RS232 port (DB9F)



CAUTION

To maintain safety (SELV) barriers and for electromagnetic compatibility, signal cables should be segregated and run separate from all other power cables.

5.1 Liebert IntelliSlot Communication Cards

The Liebert IntelliSlot port accepts four optional cards:

- Liebert IntelliSlot Web Card (IS-WEBCARD)
- Liebert IntelliSlot Relay Card (IS-RELAY)
- Liebert IntelliSlot MultiPort Card (IS-MULTIPORT)
- Liebert IntelliSlot Unity Card (IS-UNITY-DP)

The Liebert IntelliSlot Web Card provides SNMP monitoring and control of the UPS across the network.

The Liebert IntelliSlot Relay Card provides dry contact relay outputs for custom-wired applications and delivers support for Liebert MultiLink® shutdown software.

The Liebert IntelliSlot MultiPort Card provides four sets of contacts for support of up to four computers that have Liebert MultiLink installed.

The Liebert IntelliSlot Unity Card provides SNMP and/or RS-485 monitoring of the UPS across the network and/or building management system. The Liebert IntelliSlot UNITY card also enables monitoring external temperature, humidity and contact closure inputs using external sensors. (The Liebert IS-UNITY-DP compatibility will be a future release, contact your Emerson sales representative for availability.)

Follow instructions provided with the Liebert IntelliSlot card to configure Liebert MultiLink®, the UPS or any additional ancillary product for the Liebert GXT4. These instructions are available at:

multilink.liebert.com

5.1.1 Liebert MultiLink

Liebert MultiLink monitors the UPS continuously and can shut down the computer or server in the event of an extended power failure. Liebert MultiLink can also be configured to shut down the UPS.

Liebert MultiLink can communicate with the UPS via the USB port, RS232 port, contact closures via terminal block or over the network via SNMP using the Liebert IS-WEBCARD. An optional Liebert MultiLink license kit permits shutting down multiple computers that are protected by the UPS.

For more information about the Liebert IntelliSlot SNMP Card, Liebert IntelliSlot Web Card and Liebert MultiLink License Kits, visit the Liebert Web site (www.liebert.com) or contact your local Emerson® representative.

5.2 USB Port Communication

The standard B-type USB port is used to connect the UPS and network server or other computer system using Liebert MultiLink®.

A standard B-type USB port is provided to allow connection to a computer or network server. The USB port can be used to communicate with the Liebert GXT4 configuration program (see section 5.2.1 for details) or Liebert MultiLink (refer to 5.1.1 - Liebert MultiLink for description) that is provided on the CD that is included with the UPS.

5.2.1 Configuration Program

The configuration program is on the Liebert GXT4 CD and can be used instead of making configuration setting changes from the LCD panel. The configuration program communicates to a computer running a Microsoft® Windows® operating system via the included USB cable.

For most users, the factory default settings are adequate. This section give a brief overview of the features and parameters that are available for modification, as well as the factory default settings. Should any changes be necessary, refer to the Configuration Program User Manual that is located on the included CD for further details.

The configuration program allows these features of the Liebert GXT4 to be changed:

- Change and set the display language
- Enable/Disable Auto-Restart (default is Enable)
- Select frequency converter operation with a fixed output frequency of 50Hz or 60Hz, bypass disabled (default is Auto-Select with bypass enabled)
- Set the Low Battery Warning alarm time from 2 to 30 minutes (default is 2 minutes)
- Enable/Disable the Auto-Battery test (default is Enable)
- Enable/Disable Auto-Restart after removing Remote shutdown (default is Disable)
- Set the wiring mode of Remote shutdown (default is normally open)
- Set the Auto-Enable output after remote shutdown (default is Disable)
- Set the Auto-Battery test to 8, 12, 16, 20, or 26 weeks (default is 8 weeks)
- Select the number of external battery cabinets connected to the UPS to adjust the remaining run time calculated by Emerson® software products (default is zero)
- Select one of multiple output voltages to match various voltages (see **Table 8**).

Table 8 Output voltage option, all models

Factory Default Setting	Output Voltage Option
230VAC	200V, 208V, 220V, 230V, 240V

NOTICE

The output voltage settings cannot be changed while the UPS is On and powering connected loads.



NOTE

Programming the output voltage of a 230V model of the Liebert GXT4 to 220V automatically derates the UPS to 96% of both the VA and watt ratings (refer to 9.0 - Specifications for VA and watt ratings).



NOTE

- *This program is compatible with UPS models beginning with 'GXT4,' as in 'GXT4-3000RT230.' It is not compatible with earlier versions of the Liebert GXT UPS.*
- *A computer running Microsoft® Windows 2000®, Windows XP®, Windows Vista®, Windows 7 or Windows 8 is required to set up and run the configuration program.*

5.3 RS-232 Port

The RS-232 port uses an Emerson® proprietary protocol that is for use with Liebert MultiLink®. This port enables a more secure connection instead of the USB cable, to the computer or server that has Liebert MultiLink installed.

5.4 Terminal Block Communication

The Terminal Block includes eight pins, as shown in **Figure 40**.

Figure 40 Terminal Block Communication pin layout

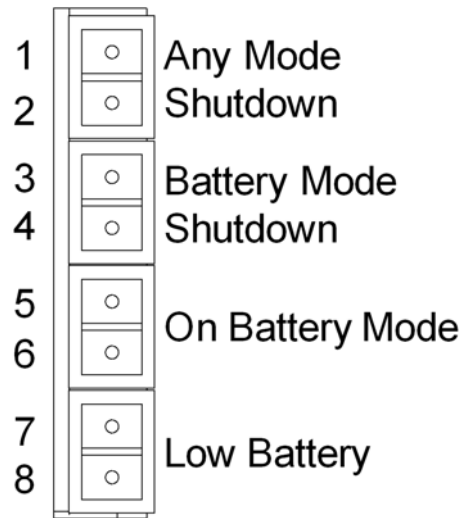

5.4.1 Any Mode Shutdown

The purpose of Any Mode Shutdown is to shut down the UPS output by turning Off the rectifier, inverter and static switch so that there is no power to the loads.

Any Mode Shutdown can be operated locally or remotely:

- Local Any Mode Shutdown can be performed by shorting Pin 1 and Pin 2.
- Remote Any Mode Shutdown can be performed using a switch connected to Pin 1 and Pin 2 and mounted at a remote location.



NOTE

Remote Power Off will be performed either by NO or NC contact of Any Mode Shutdown, depending on the settings in the configuration program.

A current-limited source for this optocoupler (+12VDC, 50mA) will be available from the UPS.

The connection to the UPS for remote connection will be via terminal block connector.

Any Mode Shutdown wiring must conform to all national, regional and local wiring regulations.



WARNING

When the Auto-Enable output option is selected and the UPS output is disabled using Pin 1 and Pin 2, the Liebert GXT4's output can turn On automatically and without warning if the Pin 1 and Pin 2 connection is changed.

5.4.2 Battery Mode Shutdown

Battery Mode Shutdown permits shutting down the UPS by turning Off the rectifier, inverter and static switch so that there is no power to the load when the UPS is On Battery. The auxiliary power for the UPS will still be active.

Battery Mode Shutdown can be performed locally or remotely:

- Local Battery Mode shutdown can be performed by shorting Pin3 and Pin4.
- Remote Battery Mode Shutdown can be performed using a switch connected to Pin3 and Pin4 and mounted at remote location.



NOTE

Remote Power Off will be performed by NO contact.

A current-limited source (+12VDC, 50mA) will be available from UPS.

The connection to the Liebert GXT4 for remote connection will be via terminal block connector.

Battery Mode Shutdown wiring must conform to all national, regional and local wiring codes and laws.

This signal must last for 1.5 seconds or longer.

A battery shutdown signal will not cause an immediate shutdown. It will start a 2-minute shutdown timer. This timer cannot be stopped once triggered. If the mains power returns during this countdown, the Liebert GXT4 will still shut down and must remain shut down for 10 seconds. Whether the UPS turns back On when the power is restored depends on the auto-restart setting.

5.4.3 On Battery

On Battery signal is a Normally Open (NO) dry contact. When the UPS is supplying output power from the battery this dry contact will be closed.

5.4.4 Low Battery

Low Battery signal is a Normally Open (NO) dry contact. When the UPS is supplying output power from the battery and has reached the Low Battery Warning time selected in the configuration program, this dry contact will be closed.



NOTE

The rated values for the dry contacts for the On Battery and Low Battery signals are:

- *Rated Voltage: 30V (AC or DC)*
- *Rated Current: 300mA*

6.0 MAINTENANCE

This section describes replacing the internal battery pack, precautions, checking the Liebert GXT4's status and checking UPS functions.



WARNING

The battery can present a risk of electrical shock and high short circuit current. The following precautions should be observed before replacing the battery pack:

- Remove rings, watches and other metal objects.
- Use tools with insulated handles.
- Do not lay tools or other metal objects on the batteries.
- If the battery kit is damaged in any way or shows signs of leakage, contact your local Emerson® representative immediately.
- Do not dispose of batteries in a fire. The batteries may explode.
- Handle, transport and recycle batteries in accordance with local regulations.

6.1 Replacing the Internal Battery Pack

The Liebert GXT4 is designed to allow the user to replace the internal battery pack safely. Refer to **Table 9** for internal battery pack part numbers for Liebert GXT4 UPS:

Table 9 Replacement battery pack model numbers

UPS Rating, VA	Replacement Internal Battery Pack Model #	Quantity Required
700/1000	GXT4-5A48BATAKIT	1
1500	GXT4-9A48BATAKIT	1
2000	GXT4-9A48BATAKIT	1
3000	GXT4-9A72BATAKIT	1

Read all safety cautions before proceeding. A trained user can replace the internal battery pack when the UPS is always in a restricted access location (such as a rack or server closet). Contact your local dealer or Emerson representative to obtain the pricing of the appropriate replacement battery pack.



CAUTION

Risk of explosion if battery is replaced by an incorrect type. Dispose of used batteries according to the instructions.

6.1.1 Battery Replacement Procedures

1. Gently remove the front plastic bezel cover from the UPS.
2. Loosen and remove the six screws on the battery door, as shown in **Figure 41**.
3. Lay the battery door and screws aside for reassembly.

Figure 41 Removing the front plastic bezel cover and battery door



4. Gently pull the battery wire out and disconnect the battery plug and battery receptacle, as shown in **Figure 42**.

Figure 42 Disconnecting the battery plug and battery connector (front view)

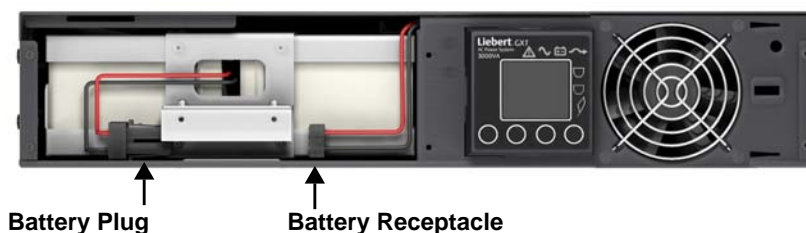

5. Grasp the battery handle and pull the internal battery pack out of the UPS, as shown in **Figure 43**.

Figure 43 Pulling out the battery



6. Unpack the new internal battery pack. Take care not to destroy the packing. Compare the new and old internal battery packs to make sure they are the same type and model. If they are the same, proceed with **Step 7**; if they are different, stop and contact your local Emerson® representative or Emerson Channel Support.
7. Line up and slide in the new internal battery pack.
8. Reconnect the battery plug and battery receptacle
9. Gently push the battery wire and internal battery pack back into the UPS.
10. Reattach the front battery door with the six screws.

11. Reattach the front plastic bezel cover to the UPS.

**NOTE**

The internal battery pack is hot-swappable. However, caution should be exercised because during this procedure the load is unprotected from disturbances and power outages.

Do not replace the battery while the UPS is in Battery Mode. This will result in a loss of output power and will drop the connected load.

6.2 Battery Charging

The batteries are valve-regulated, nonspillable, lead acid and should be kept charged to attain their design life. The Liebert GXT4 charges the batteries continuously when it is connected to the mains input power.

If the Liebert GXT4 will be stored for a long time, Emerson recommends connecting the UPS to input power for at least 24 hours every three to four months to ensure full recharge of the batteries.

6.3 Precautions

Although the Liebert GXT4 has been designed and manufactured to ensure personal safety, improper use can result in electrical shock or fire. To ensure safety, observe the following precautions:

- Turn Off and unplug the Liebert GXT4 before cleaning it.
- Clean the UPS with a dry cloth. Do not use liquid or aerosol cleaners.
- Never block or insert any objects into the ventilation holes or other openings of the UPS.
- Do not place the Liebert GXT4 power cord where it might be damaged.

6.4 Checking UPS Status

Emerson® recommends checking the UPS operation status every six months.

- Check whether the UPS is faulty: Is the Fault Indicator On? Is the UPS sounding an alarm?
- Check whether the UPS is operating in Bypass Mode. Normally, the UPS operates in Normal Mode. If it is operating in Bypass Mode, stop and contact your local Emerson representative, or Emerson Channel Support.
- Check whether the battery is discharging. When the mains input is normal, the battery should not discharge. If the UPS is operating in Battery Mode, stop and contact your local Emerson representative or Emerson Channel Support.

7.0 TROUBLESHOOTING

This section indicates various UPS symptoms a user may encounter and provides a troubleshooting guide in the event the UPS develops a problem. Use the following information to determine whether external factors caused the problem and how to remedy the situation.

7.1 UPS Symptoms

The following symptoms indicate the Liebert GXT4 is malfunctioning:

- The relative indicators illuminate, indicating the UPS has detected a problem.
- An alarm buzzer sounds, alerting the user that the UPS requires attention.

7.1.1 Indicator and LCD

In addition to the fault indicator being illuminated, the LCD will display the fault. The displayed fault on the LCD is described in **Table 10**

Table 10 Description of the displayed fault

Displayed Fault	Cause	Corrective Steps
UPS self test failed	The battery is bad or weak.	Contact customer service.
UPS shutdown command received	The UPS shuts down through communication.	Contact customer service.
UPS overload	The UPS is overloaded.	Reduce the load and contact customer service.
Inverter Out of Order	The inverter is faulty.	Contact customer service.
Battery Weak/Bad	The battery is bad or weak.	Replace the battery.
Output Short Circuit	The output connection is short-circuited.	Shut down the equipment and contact customer service.
DC Bus Overvoltage	The DC bus is faulty.	Contact customer service.
UPS Overtemperature	Over-temperature occurs to the UPS and the UPS will transfer to Bypass mode.	Reduce the load and contact customer service.
Charger Out of Order	The charger is faulty.	Contact customer service.
Fan Out of Order	At least one fan is faulty.	Contact customer service.
DC Bus Discharge Fail	A DC-DC failure occurs.	Contact customer service.



NOTE

If the UPS encounters a fault and no correction attempt is performed within 2 minutes, the LCD backlight will flash (on 1 second and off 1 second) as an alert.

Press any button to exit the alert mode. If no correction attempt is performed on the UPS, the LCD backlight will flash again until the UPS fault is corrected.

7.1.2 Audible Alarm

An audible alarm will sound in conjunction with the visual indicators to indicate a change in UPS operating status. The audible alarm will sound as described in **Table 11**.

Table 11 Audible alarm description

Condition	Alarm
Battery discharge	Half-second beep every 10 seconds
Low battery	Two half-second beeps every 5 seconds
UPS fault, load on bypass	1-second beep every 4 seconds
UPS fault, no power to load	Continuous
Overload	Half-second beep every half second
Battery replacement	2-second beep every 2 minutes
Battery loss	Continuous
Wiring problem (loss of proper grounding for UPS)	Continuous
Bypass reminder	1-second beep every 60 seconds

7.2 Troubleshooting

In the event of an issue with the UPS, refer to **Table 12** to determine the cause and solution. If the fault persists, contact Emerson® Channel Support.

Table 12 Troubleshooting table

Problem	Cause	Solution
UPS fails to start	UPS is short-circuited or overloaded	Ensure UPS is Off. Disconnect all loads and ensure nothing is lodged in output receptacles. Ensure loads are not defective or shorted internally.
	Batteries are not charged enough or not connected	Check to ensure the internal battery is connected. If it is not, make the connection and try to start the unit. If the battery is connected, leave the UPS connected to input power for 24 hours to recharge batteries, then try to start the unit.
Battery indicator is illuminated	UPS is not plugged in	UPS is operating from battery mode. Ensure UPS is securely plugged into the wall receptacle.
	UPS input protection fuse has blown/opened	UPS is operating from battery mode. Save data and close applications. Replace UPS input fuse, then restart UPS.
	Mains power is out of tolerance	UPS is operating from battery mode. Save data and close applications. Ensure mains supply voltage is within acceptable limits for UPS.
UPS has reduced battery backup time	Batteries are not fully charged	Keep UPS plugged in continuously at least 24 hours to recharge batteries.
	UPS is overloaded	Check load level indicator and reduce the load on the UPS.
	Batteries may not be able to hold a full charge due to age	Replace batteries. Contact your local dealer, Emerson representative or Emerson Channel Support for replacement battery kit.
Battery indicator is flashing.	Battery source is not available; continuous horn.	Check battery connections, completely power down and restart UPS. NOTE: If the battery circuit opens while the UPS is running, it will be detected when the next battery test is performed.
Bypass indicator is flashing.	Because the voltage or frequency is outside acceptable limits, the bypass is disabled.	The AC input powers the PFC input and serves as the bypass source. If the AC is present but the voltage or frequency exceeds the acceptable range for safe operation with a load, the bypass will be disabled and this indicator will flash, indicating that the bypass is unavailable.

When reporting a UPS issue to Emerson, include the UPS model and serial number. These are located in several places for your ease of location: on the top panel (rack mount orientation); the left side (tower orientation); the rear panel; on the front of the unit behind the front plastic bezel; and on the LCD select *MAIN MENU > ABOUT*.

8.0 BATTERY CABINET

Optional battery cabinets are available for the Liebert GXT4. The external battery connector and isolation breaker are on the battery cabinet's rear panel, as shown in **Figure 44**. For battery cabinet specifications, refer to **Table 15**.

Figure 44 Battery cabinet

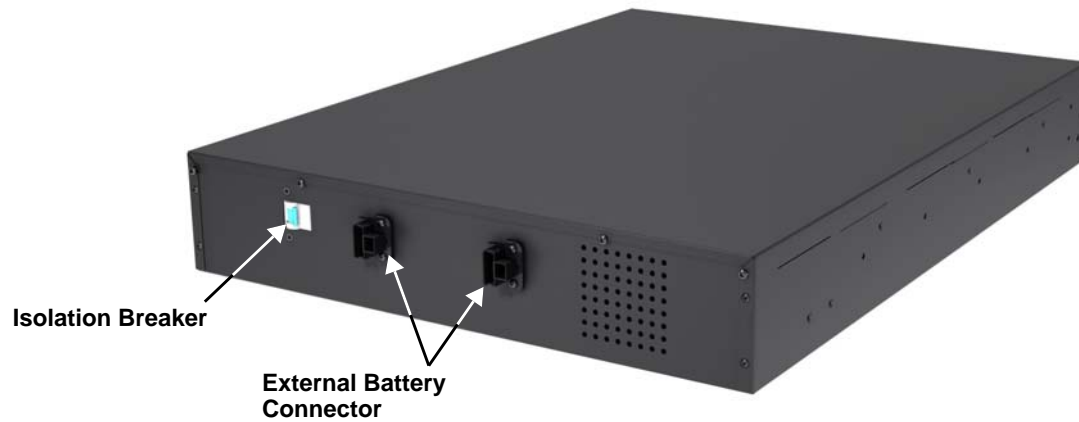

WARNING

Do not contact the external battery connector and ground without wearing protective gloves and clothing and taking other precautions against electrical shock. The battery loop and AC input are not insulated, which may cause a dangerous voltage between the external battery connector and ground.



NOTE

External battery connectors are wired in parallel. Either connector can be connected to the UPS or to another battery cabinet.



NOTE

The length of the standard battery cable delivered with the battery cabinet is 0.65m (2.13ft).

9.0 SPECIFICATIONS

The specifications of the Liebert GXT4 are listed in **Table 13** and **Table 14**.

Table 13 Specifications of GXT4-700RT230/230E and GXT4-1000RT230/230E UPS

Parameters	Product model	
	GXT4-700RT230 GXT4-700RT230E	GXT4-1000RT230 GXT4-1000RT230E
Model Rating	700VA/630W	1000VA/900W
Dimensions, D x W x H, mm (in)		
Unit	408 x 430 x 85 (16.2 x 16.9 x 3.4)	
Shipping	617 x 570 x 262 (24.3 x 22.4 x 10.3)	
Weight, kg (lb)		
Unit	18.2 (40)	
Shipping	24 (53); "E" model 20 (44)	
Input AC		
Voltage Range (typical)	230VAC nominal; variable based on output load	
90% ~ 100% loading	177VAC/280VAC	
70% ~ 90% loading	168VAC/280VAC	
30% ~ 70% loading	150VAC/280VAC	
0 ~ 30% loading	115VAC/280VAC	
Frequency	40Hz ~ 70Hz; Auto Sensing	
Input Power Receptacle	C14	
Output AC		
AC-AC Efficiency	> 88% AC-AC, minimum	
Output Receptacles	C13 x 6	
Voltage	200/208/220/230/240VAC (user configurable); ±3%	
Frequency	50Hz or 60Hz	
Waveform	Sine wave	
Mains (AC) Mode Overload	200% for 2 seconds; 150% for 50 seconds with transfer to bypass	
Internal Battery Charger		
Charger Current, Amperes	1.3	
Battery		
Type	Valve-regulated, nonspillable, lead acid	
Qty x Vx Rating	4 x 12V x 5.0Ah	
Battery Mfr/Part#	YUASA/NPH5-12; CSB/ HR 1221W; CSB/GP1245	
Backup Time	See Table 17 - Battery run times	
Recharge Time	5 hours to 90% capacity after full discharge with 100% load till UPS auto-shutdown (Internal Batteries Only)	
Environmental Requirements		
Operating Temp	0°C to +40°C (+32°F to +104°F); Table 16 - Operating temperature parameters	
Storage Temp	-15°C to +50°C (5°F to 122°F)	
Relative Humidity	0%RH to 95%RH, non-condensing	
Operating Elevation	Up to 3000m (10,000 ft.) at 25°C (77°F) without derating	
Storage Elevation	15,240 (50,000 ft.) maximum	
Audible Noise	< 46 dBA, at 1 meter (3.2ft) from the rear < 43 dBA, at 1 meter (3.2ft) from the front or sides	
Agency		
Safety	IEC/EN/AS 62040-1:2008, GS mark; UL 1778 Listed	
RFI/EMI	IEC/EN/AS 62040-2 2nd Ed (Category C2) = CISPR22 Class A	
Surge Immunity	IEC/EN 62040-2 2nd Ed (IEC/EN 61000-4-5)	
Transportation	ISTA Procedure 1A	

Table 14 Specifications of the Liebert GXT4-1500RT230/230E, GXT4-2000RT230/230E and GXT-3000RT230/230E

Parameters	Product model			
	GXT4-1500RT230	GXT4-1500RT230E	GXT4-2000RT230 GXT4-2000RT230E	GXT4-3000RT230 GXT4-3000RT230E
Model Rating	1500VA/1350W		2000VA/1800W	3000VA/2700W
Dimensions, D x W x H, mm (in)				
Unit	497 x 430 x 85 (19.6 x 16.9 x 3.3)			602 x 430 x 85 (23.7 x 16.9 x 3.3)
Shipping	617 x 570 x 262 (24.3 x 22.4 x 10.3)			717 x 570 x 262 (28.2 x 22.4 x 10.3)
Weight, kg (lb)				
Unit	23.2 (51.1)		25.5 (56.1)	32.4 (71.4)
Shipping	30 (66.1) "E" model: 26 (57.3)		32 (70.5) "E" model: 28 (61.7)	39 (86) "E" model: 35 (77.2)
Input AC				
Voltage Range (typical)	230VAC nominal; variable based on output load			
90% ~ 100% loading	177VAC/280VAC			196VAC/280VAC
70% ~ 90% loading	168VAC/280VAC			184VAC/280VAC
30% ~ 70% loading	150VAC/280VAC			161VAC/280VAC
0 ~ 30% loading	115VAC/280VAC			115VAC/280VAC
Frequency	40Hz ~ 70Hz; Auto Sensing			
Input Power Receptacle	C14		C20	
Output AC				
AC-AC Efficiency	> 88% AC-AC, minimum			
Output Receptacles	C13 x 6			C13 x 6; C19 x 1
Voltage	200/208/220/230/240VAC (user configurable); ±3%			
Frequency	50Hz or 60Hz			
Waveform	Sine wave			
Mains (AC) Mode Overload	200% for 2 seconds; 150% for 50 seconds			200% for 2 seconds; 150% for 55 seconds
Internal Battery Charger				
Charger Current, Amperes	1.88		2.71	2.5
Battery				
Type	Valve-regulated, nonspillable, lead acid			
Qty x V x Rating	4 x 12V x 9.0Ah	4 x 12V x 7.0Ah	4 x 12V x 9.0Ah	6 x 12V x 9.0Ah
Battery Mfr/Part#	Panasonic/UP-RW1245; CSB/ HR 1234W F2; CSB/UPS 12460 F2; and CSB/UPS123607 F2 for GXT4-1500RT230E only			
Backup Time	See Table 17 - Battery run time			
Recharge Time to 90% capacity after full discharge with 100% load till UPS auto-shutdown (Internal Batteries Only)	6 hours		5 hours	
Environmental Requirements				
Operating Temp	0°C to 40°C (32°F to 104°F); Table 16 - Operating temperature parameters			
Storage Temp	-15°C to +50°C (5°F to 122°F)			
Relative Humidity	0%RH to 95%RH, non-condensing			
Operating Elevation	Up to 3000m (10,000 ft.) at 25°C (77°F) without derating			
Storage Elevation	15000m (50,000 ft.) maximum			
Audible Noise	< 45 dBA max. at 1 meter (3.2ft.) front and side < 46 dBA, at 1 meter (3.2ft.) rear		< 48 dBA max. at 1 meter (3.2ft.) front and side < 48 dBA, at 1 meter (3.2ft.) rear	

Table 14 Specifications of the Liebert GXT4-1500RT230/230E, GXT4-2000RT230/230E and GXT-3000RT230/230E

Parameters	Product model			
	GXT4-1500RT230	GXT4-1500RT230E	GXT4-2000RT230 GXT4-2000RT230E	GXT4-3000RT230 GXT4-3000RT230E
Model Rating	1500VA/1350W		2000VA/1800W	3000VA/2700W
Agency				
Safety	IEC/EN/AS 62040-1:2008, GS mark; (3000VA model: UL 1778 Listed)			
RFI/EMI	IEC/EN/AS 62040-2 2nd Ed. (Category C2) = CISPR22 Class A			
Surge Immunity	IEC/EN 62040-2 2nd Ed. (IEC/EN 61000-4-5)			
Transportation	ISTA Procedure 1A			

Table 15 Battery cabinet specifications

Parameter	Model Number	
	GXT4-48VBATT GXT4-48VBATTE	GXT4-72VBATT GXT4-72VBATTE
Used w/UPS Model	GXT4-700RT230/230E, GXT4-1000RT230/230E, GXT4-1500RT230/230E, GXT4-2000RT230/230E	GXT4-3000RT230/230E
Dimensions, D x W x H, mm (in)		
Unit	497 x 430 x 85 (19.7 x 16.9 x 3.3)	602 x 430 x 85 (23.6 x 16.9 x 3.3)
Shipping	617 x 570 x 262 (24.3x 22.4 x 10.3)	717 x 570 x 262 (28.2 x 22.4 x 10.3)
Weight, kg (lb)		
Unit	32 (70.5)	42 (92.6)
Shipping	39 (86) "E" model 35 (77.2)	50 (110) "E" model 46 (101.4)
Battery parameters		
Type	Valve-regulated, nonspillable, lead acid	
Qty x Vx Rating	2 x 4 x 12V x 9.0Ah	2 x 6 x 12V x 9.0Ah
Battery Mfr/Part#	Panasonic/UP-RW1245 CSB/HR 1234W F2; CSB/UPS 12460 F2	
Backup Time	See Table 17 - Battery run times	
Environmental		
Operating Temperature	0°C to 40°C (32°F to 104°F)	
Storage Temperature	-15°C to +40°C (19°F to 104°F)	
Relative Humidity	0% to 95%, non-condensing	
Operating Elevation	Up to 3000m (10,000 ft.) at 40°C (104°F) without derating	
Storage Elevation	15000m (50,000 ft.) maximum	
Agency		
Safety	IEC/EN/AS 62040-1:2008, GS mark	
RFI/EMI	FCC Part 15, Class A=CISPR22 Class A	
Surge Immunity	IEC 62040-2 2nd Ed.: 2006	
Transportation	ISTA Procedure 1A	

Table 16 Operating temperature parameters

Ambient Temperature, °C (°F)	25-30 (77-86)	30-35 (86-95)	35-40 (95-104)
Maximum Output Power Factor Derating @ Maximum Load	100%-93%	93%-86%	86%-79%

Table 17 Battery run times

Number of Batteries/Cabinets	Load Percent of Capacity	Run Time, Minutes *					
		700VA	1000VA	1500VA	1500VA E Model	2000VA	3000VA
Internal Battery	10%	105	91	112	75	81	91
	20%	62	38	51	36	37	39
	30%	37	31	34	23	23	23
	40%	32	23	23	16	16	16
	50%	27	17	18	12	12	12
	60%	22	14	14	9	9	9
	70%	18	11	11	7	7	7
	80%	15	9	9	6	5	5
	90%	13	8	7	5	4	4
	100%	11	6	6	4	3	3
Internal Battery + 1 External Battery Cabinet	10%	427	334	330	321	222	302
	20%	303	166	160	152	137	139
	30%	164	138	128	108	94	95
	40%	145	108	97	81	66	66
	50%	126	92	72	66	49	48
	60%	106	72	54	51	39	41
	70%	94	56	46	40	34	34
	80%	78	48	38	35	28	27
	90%	69	40	34	31	23	23
	100%	61	37	31	26	20	21
Internal Battery + 2 External Battery Cabinets	10%	480	457	447	404	426	431
	20%	434	333	315	306	201	205
	30%	329	224	186	175	149	150
	40%	273	166	151	142	124	124
	50%	203	151	131	123	97	97
	60%	164	135	107	100	75	76
	70%	153	113	92	81	61	63
	80%	142	103	74	71	50	50
	90%	131	92	64	62	41	45
	100%	121	78	53	49	38	41
Internal Battery + 3 External Battery Cabinets	10%	480	480	467	432	451	455
	20%	461	442	424	399	322	325
	30%	439	337	311	284	195	196
	40%	345	305	199	179	154	155
	50%	323	208	160	155	136	136
	60%	300	166	146	136	111	112
	70%	213	155	131	126	96	98
	80%	189	144	111	105	78	79
	90%	163	132	99	94	68	70
	100%	156	122	83	80	56	60

Table 17 Battery run times (continued)

Number of Batteries/Cabinets	Load Percent of Capacity	Run Time, Minutes *					
		700VA	1000VA	1500VA	1500VA E Model	2000VA	3000VA
Internal Battery + 4 External Battery Cabinets	10%	480	480	480	480	466	480
	20%	480	460	444	428	421	423
	30%	458	436	340	320	306	307
	40%	442	340	309	286	192	192
	50%	425	315	205	201	157	157
	60%	336	218	165	161	142	143
	70%	319	195	153	149	127	128
	80%	301	165	141	138	107	109
	90%	213	156	130	126	95	97
	100%	197	147	112	108	80	81
Internal Battery + 5 External Battery Cabinets	10%	480	480	480	480	480	480
	20%	480	467	457	434	438	440
	30%	465	447	431	410	331	332
	40%	452	428	333	316	224	225
	50%	438	341	307	286	189	189
	60%	425	320	208	201	158	159
	70%	344	227	167	161	146	147
	80%	329	208	158	153	133	135
	90%	315	189	148	144	120	122
	100%	301	164	139	135	104	106
Internal Battery + 6 External Battery Cabinets	10%	480	480	480	480	480	480
	20%	480	480	466	456	450	452
	30%	480	458	444	434	420	421
	40%	462	442	422	404	319	319
	50%	451	426	328	314	217	217
	60%	440	341	305	284	186	187
	70%	428	323	209	201	159	160
	80%	368	306	184	178	148	150
	90%	336	217	161	155	137	139
	100%	325	201	153	149	126	128

* The times above are approximate. They are based on new, fully charged standard batteries at a temperature of 25°C (77°F) with 100% resistive UPS loading. The listed run times can vary by ±5% because of manufacturing variances of the batteries.

9.1 Product Warranty Registration

Registration is not required to activate the product warranty on a Liebert UPS. Registration is required to qualify for the Product Protection Promise. To register, visit the Emerson Network Power® Web site to fill out the online form at:

www.emersonnetworkpower.com/en-US/Forms/Pages/LiebertProductWarrantyRegistration.aspx

- To contact warranty support by e-mail: dpg.warranty@emerson.com

9.2 Technical Support

Technical support contacts are listed on the back cover of this document. To contact Emerson Channel Product Support:

Phone

- NORTH AMERICA: 1-800-222-5877
- OUTSIDE NORTH AMERICA: 00-800-1155-4499

E-mail

- TECHNICAL SUPPORT: liebert.upstech@emerson.com

Technical Support / Service

Web Site

www.liebert.com

Monitoring

liebert.monitoring@emerson.com

800-222-5877

Outside North America: +00800 1155 4499

Single-Phase UPS & Server Cabinets

liebert.upstech@emerson.com

800-222-5877

Outside North America: +00800 1155 4499

Three-Phase UPS & Power Systems

800-543-2378

Outside North America: 614-841-6598

Environmental Systems

800-543-2778

Outside the United States: 614-888-0246

Locations

United States

1050 Dearborn Drive

P.O. Box 29186

Columbus, OH 43229

Europe

Via Leonardo Da Vinci 8

Zona Industriale Tognana

35028 Piove Di Sacco (PD) Italy

+39 049 9719 111

Fax: +39 049 5841 257

Asia

29/F, The Orient Square Building

F. Ortigas Jr. Road, Ortigas Center

Pasig City 1605

Philippines

+63 2 687 6615

Fax: +63 2 730 9572

While every precaution has been taken to ensure the accuracy and completeness of this literature, Liebert Corporation assumes no responsibility and disclaims all liability for damages resulting from use of this information or for any errors or omissions.

© 2014 Liebert Corporation

All rights reserved throughout the world. Specifications subject to change without notice.

© Liebert is a registered trademark of Liebert Corporation.

All names referred to are trademarks

or registered trademarks of their respective owners.

SLI-23196_REV1_05-15

Emerson Network Power

Liebert

www.emerson.com