

## DH-IPC-HDBW2201R-ZS/VFS

---

2MP Full HD WDR Water-Proof & Vandal-Proof Network Dome Camera



### Features

- 1/3" 2Megapixel progressive scan Aptina CMOS
- H.264 & MJPEG dual-stream encoding
- 25/30fps@1080P(1920x1080) & 25/30fps@720P(1280x720)
- Day/Night(ICR), 3DNR, AWB, AGC, BLC, WDR(120dB)
- Multiple network monitoring: Web viewer, CMS(DSS/PSS) & DMSS
- 2.7~12mm varifocal lens
- Max IR LEDs Length 30m
- IP66, IK10, PoE

# DH-IPC-HDBW2201R-ZS/VFS

## Technical Specifications

Model	DH-IPC-HDBW2201R-VFS		DH-IPC-HDBW2201R-ZS
<b>Camera</b>			
Image Sensor	1/3" 2Megapixel progressive scan Aptina CMOS		
Effective Pixels	1920(H)x1080(V)		
Scanning System	Progressive		
Electronic Shutter Speed	Auto/Manual, 1/3(4)~1/10000s		
Min. Illumination	0. 1Lux/F1.4(Color); 0Lux/F1.4(IR on)		
S/N Ratio	More than 50dB		
Video Output	N/A		
<b>Camera Features</b>			
Max. IR LEDs Length	30m		
Day/Night	Auto(ICR)/Color/B/W		
Backlight Compensation	BLC / HLC / WDR		
White Balance	Auto/Manual		
Gain Control	Auto/Manual		
Noise Reduction	3D		
Privacy Masking	Up to 4 areas		
<b>Lens</b>			
Focal Length	2.7mm~12mm	2.7mm~12mm	
Max Aperture	F1.4	F1.4	
Focus Control	Manual	Auto	
Angle of View	H: 82° ~28°	H: 82° ~28°	
Lens Type	Manual/Fixed Iris	Motorized/Fixed Iris	
Mount Type	Board-in Type	Board-in Type	
<b>Video</b>			
Compression	H.264/ H.264H/ H.264B/ MJPEG		
Resolution	1080P(1920x1080)/1.3M(1280x960)/720P(1280x720)/D1(704x576 /704x480)/CIF(352x288/352x240)		
Frame Rate	Main Stream	1080P/720P(1 ~ 25/30fps)	
	Sub Stream	D1/CIF(1 ~ 25/30fps)	
Bit Rate	H.264: 40K ~ 8192Kbps		
<b>Audio</b>			
Compression	N/A		
Interface	N/A		
<b>Network</b>			
Ethernet	RJ-45 (10/100Base-T)		
Wi-Fi	N/A		
Protocol	IPv4/IPv6, HTTP, HTTPS, SSL, TCP/IP, UDP, UPnP, ICMP, IGMP, SNMP, RTSP, RTP, SMTP, NTP, DHCP, DNS, PPPOE, DDNS, FTP, IP Filter, QoS, Bonjour		
Compatibility	ONVIF, PSIA, CGI		
Max. User Access	20 users		

## DH-IPC-HDBW2201R-ZS/VFS

Smart Phone	iPhone, iPad, Android, Windows Phone	
<b>Auxiliary Interface</b>		
Memory Slot	Micro SD, Max 64GB	
RS485	N/A	
Alarm	N/A	
PIR Sensor Range	N/A	
<b>General</b>		
Power Supply	DC12V, PoE (802.3af)	
Power Consumption	<4W	<7.5W
Working Environment	-30°C~+60°C, Less than 95% RH	
Ingress Protection	IP66	
Vandal Resistance	IK10	
Dimensions	φ122mm×89mm	
Weight	0.5kg	

# DH-IPC-HDBW2201R-ZS/VFS

## Dimensions (mm)

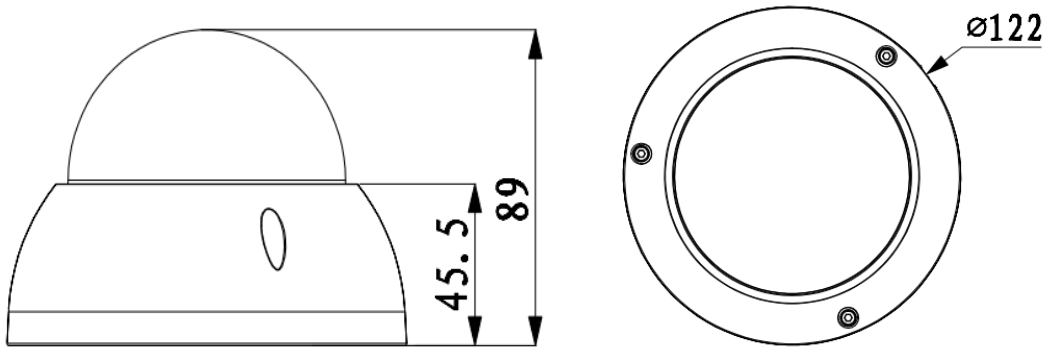

## Accessories(optional)



---

### Dahua Technology Co., Ltd.

1199 BinAn Road, Binjiang District, Hangzhou, China

Tel: +86-571-87688883

Fax: +86-571-87688815

Email: overseas@dahuatech.com

www.dahuasecurity.com

\*Design and specifications are subject to change without notice.

© 2014 Dahua Technology Co., Ltd.